

FM 7-37

Cannon Company

Cannon Company was unique to the 1940's and is now almost forgotten.

The United States Army has traditionally relied heavily on its artillery establishment, and since the Mexican War it has excelled in this most technical of combat arms. Cannon company proved useful in the extreme, providing organic indirect fire support to supplement the 60mm and 81mm mortars at company and battalion. It was common enough for divisional assets to be assigned in direct support of regiments (generally the 105mm DS battalions), but the addition of Cannon Company provided a powerful weapon for the regimental commander to use at his discretion. Unlike the lighter mortars, Cannon Company could at needs provide indirect fire support directed and adjusted by forward observers; mortars in the regiment had to see what they were firing at to be fully effective.

Cannon Company was unique in that it was an infantry unit (which is why it is called a company and not a battery), manned by infantry soldiers trained by the artillery. The artillery didn't much care for this, since it was a drain on their own personnel and training facilities. Eventually (after the shooting stopped!) the Infantry let Cannon Company go.

The equipment used was the M3 light howitzer, a smaller version of the M1 used by most DS artillery units. (The division artillery in the Airborne Divisions used the M3 as well.) It was a serviceable piece, and did not require a heavy prime mover (a 1 ½ ton WC would do the trick). It did eat ammo at a high rate, however, which put pressure on transportation assets of the Service company.



WAR DEPARTMENT FIELD MANUAL
FM 7-37

This manual supersedes War Department Training Circular No. 121,
9 November 1943.

CANNON COMPANY,
INFANTRY REGIMENT



WAR DEPARTMENT

28 MARCH 1944

United States Government Printing Office
Washington: 1944

WAR DEPARTMENT,
Washington 25, D. C., 28 March 1944.

FM 7-37, Infantry Field Manual, Cannon Company,
Infantry Regiment, is published for the information
and guidance of all concerned.

[A.G. 300.7 (30 Apr 44).]

By order of the Secretary of War:

G. C. MARSHALL,
Chief of Staff.

OFFICIAL:

J. A. ULIO,
Major General,
The Adjutant General.

DISTRIBUTION:

Bn and H 7(5) ; IC 7(10).

For explanation of symbols see FM 21-6.

TABLE OF CONTENTS

	Paragraphs
CHAPTER 1. General.	
<i>Section</i> I. Composition, armament, equipment, and transport	1-5
II. Tactical employment	6-11
III. Protective measures	12-17
CHAPTER 2. Supply, medical service, and evacuation.	
<i>Section</i> I. Supply	18-21
II. Medical service and evacuation	22-26
CHAPTER 3. Marches and bivouacs.	
<i>Section</i> I. Marches	27-30
II. Bivouacs	31
CHAPTER 4. Offensive combat.	
<i>Section</i> I. Approach march and assembly area	32-33
II. Employment in the attack	34-37
III. Special operations	38-45
CHAPTER 5. Defensive combat.	
<i>Section</i> I. General	46
II. Employment in defense	47-49
III. Retrograde movements	50-54
IV. Special operations	55-60
<i>Appendix</i> I. Stream crossing expedients for howitzers and vehicles.	

[Appendices II-III omitted.]

Chapter 1 GENERAL

Section I. COMPOSITION, ARMA- MENT, EQUIPMENT, AND TRANSPORT

1. COMPOSITION. The cannon company of the infantry regiment consists of a company headquarters and three cannon platoons. (See figure 1.) The company headquarters is composed of a command group and an administration group.

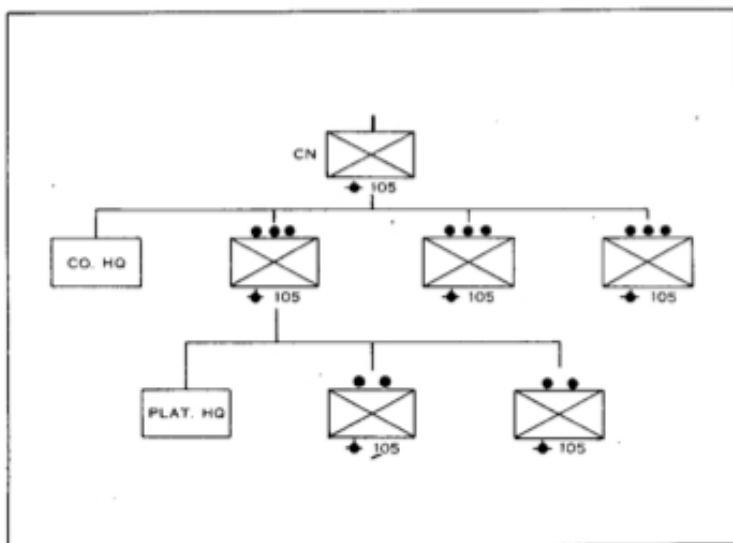

Figure 1. Composition of the cannon company.

a. The command group. The *command group* includes the company commander (regimental howitzer

Cannon Company is a strange and wonderful idea that barely survived the war. It is basically an artillery battery manned by infantrymen trained by the field artillery, to provide a flexible "pocket direct support" package for the regimental commander.

Besides being called a "company" instead of a "battery", it differs in organization and employment from a howitzer battery in the artillery. Instead of typically being employed as a battery of six tubes firing together from a single fire direction center (see ST-3), it is divided into three platoons of two howitzers each; this allows the regimental commander to form smaller packages that artillery doctrine allows, based on the faster pace of maneuver far forward in the regimental zone.

Cannon Company is equipped with the 105mm howitzer M3, a smaller version of the standard M2 used in artillery 105mm battalions (the M3 is also used by 105 battalions in the airborne divisions). Just before and early into the war, cannon company was equipped with the 75mm pack howitzer (so called because it could be broken down into pack loads suitable for mules).

officer), reconnaissance officer (second-in-command), 1st sergeant, reconnaissance sergeant, communication sergeant, transportation sergeant, radiotelephone operators, automobile mechanic, bugler, messengers, truck driver (who drives the company headquarters 1½-ton cargo truck), and basic privates. The company commander employs the command group primarily to assist him in making the necessary preparations for employing the company in combat and in controlling it during combat. Duties of individuals are as follows:

(1) (a) The company commander is responsible for the training, discipline, control, administration, and supply of his company. He is also responsible for its tactical employment in conformity with orders received from the regimental commander.

(b) Through timely reconnaissance, he assists the regimental commander in the development of the plan for employing the weapons of the company, and is usually required to submit recommendations to the regimental commander for their employment. Thereafter, he issues the necessary orders to his platoon leaders for the employment of their platoons.

(c) During combat the company commander also—

1. Maintains liaison with the regimental commander; keeps him informed of the situation insofar as it pertains to the employment of the cannon company; and keeps himself prepared to submit recommendations for changes required in its employment or disposition.
2. Exercises initiative of a high order in bringing about the proper employment of the cannon company, and encourages the platoon leaders to do likewise, by advising the supported unit commanders appropriately, and by seeking and proposing missions when none are assigned or requested.
3. Establishes an observation post near that of the regimental commander in order that he may effectively employ the platoon (s) held under his control, and makes timely rec-

ommendations to the regimental commander for changes in the employment of the company.

4. Maintains contact with his platoons.
5. Makes, or causes to be made, the reconnaissance required for new position areas, sectors of fire, and routes of displacement for weapons and vehicles. (See par. 11.)
6. Orders and supervises the displacement of weapons in accordance with the regimental plan of action.
7. Insures the maintenance of an adequate supply of ammunition.

(2) The reconnaissance officer, who is second-in-command of the company, keeps abreast of the tactical situation as it affects the company. His primary duty is reconnaissance for initial and subsequent firing position areas, targets, and routes for displacement and ammunition supply. He is assisted by the reconnaissance sergeant, messengers, and such other personnel as the company commander may designate.

(3) The first sergeant is the principal enlisted assistant of the company commander. Under the supervision of the latter, he establishes and operates the company command post. His duties will vary widely during combat, from administrative and supply matters to actual command of a platoon, if casualties necessitate such replacement. When the communication sergeant is performing duties away from the company command post, the first sergeant may be required to operate or supervise the operation of the company message center.

(4) The reconnaissance sergeant performs such reconnaissance as may be assigned to him by the company commander or reconnaissance officer. He may assist in the establishment of the observation post, and may also act as a guide.

(5) The communication sergeant is responsible for the establishment and operation of the unit message center at the company command post, and the operation and maintenance of communication

equipment throughout the company. In performing this mission, he is assisted by the bugler, messengers, and such other personnel as the company commander may direct. He is charged with the training of the personnel engaged in the installation, operation, and maintenance of the communication equipment issued to the company.

(6) The transportation sergeant is in charge of the company transport. He supervises the operation and maintenance of the motor vehicles of the company. During combat he assists the supply sergeant and controls the movement of vehicles engaged in ammunition supply between the regimental ammunition supply point and platoon areas. (See par. 21.) He supervises the camouflage and concealment of vehicles and takes steps to insure their maximum protection against enemy air and mechanized attack.

(7) The radiotelephone operators are responsible for the operation and maintenance of their sets.

(8) The automobile mechanic performs company maintenance of company transportation under the supervision of the transportation sergeant. He drives the $\frac{3}{4}$ -ton weapon carrier.

(9) The bugler is trained to act as a signalman, foot or motor messenger, and observer. He drives one of the company headquarters $\frac{1}{4}$ -ton trucks.

(10) The messengers may be employed as foot or motor messengers, observers, guides, and assistants to other personnel at the company command post. Each drives one of the company headquarters $\frac{1}{4}$ -ton trucks.

(11) Basic privates are trained as replacements and as messengers. Until assigned as replacements, they are employed as directed by the company commander.

(12) The bugler, messengers, automobile mechanic, and driver of the company headquarters $1\frac{1}{2}$ -ton truck are responsible for the habitual camouflage, concealment, and driver maintenance of their individual vehicles.

b. The administration group. The *administration group* consists of the supply sergeant, mess sergeant,

company clerk, armorer-artificer, two cooks and two cooks' helpers. Personnel of the administration group are employed by the company commander to assist him in the execution of the supply and administrative functions of the company. Their duties are as follows:

(1) The supply sergeant is responsible for receiving, checking, and distributing supplies, except rations and water, and for supervising the activities of the armorer-artificer. He keeps the company commander informed of the needs of the company. During combat he will usually be in the forward area assisting the company commander in matters relating to supply, or at the company ammunition supply point supervising the supply of ammunition. The armorer-artificer will usually be located in the train bivouac, where he assists in the checking and distribution of supplies, executes minor repairs on weapons, and performs simple carpentry tasks.

(2) The mess sergeant is responsible for receiving and checking the rations and water issued to the company, the division of rations into meals, the supervision of the cooks and cooks' helpers in the preparation of meals, and the preparation and distribution of meals to the company. Except while distributing meals in the forward area, he and his assistants are usually in the regimental train bivouac, working under the direct supervision of the service company commander.

(3) The company clerk keeps the company records. As a member of the regimental personnel section, he functions under the military personnel officer. In combat, the personnel section may be separated from the regiment, and operate and move with the rear echelon of the division or corps; otherwise, it operates in the regimental train bivouac.

2. COMPOSITION OF CANNON PLATOON.

Each platoon is composed of a command group (headquarters) and two sections. The command group consists of a platoon leader, platoon sergeant, agent corporal, instrument operator, radiotelephone operator, artillery mechanic, ammunition handler,

messenger, and ammunition truck driver.

a. Each section consists of a sergeant chief of section, corporal gunner, seven cannoneers, and driver of the prime mover.

b. The platoon leader is responsible for the training, discipline, control, and tactical employment of his platoon. He receives his orders from the company commander, except when the platoon is attached to another unit. Assisted by his command group, he controls the action of the platoon through timely orders and instructions. For communication he employs foot messengers, vehicle drivers, telephone equipment, radiotelephones, and visual signals. He executes fire missions specifically assigned to the platoon or required by mission-type orders, and coordinates the action of the platoon with that of the supported unit.

c. The platoon sergeant is second-in-command of the platoon. He takes charge when the platoon leader is absent, and commands the rear elements of the platoon during displacements. He supervises ammunition supply and communication within the platoon. When the platoon fires as a unit, he supervises the action at the firing position and controls the firing through transmission of orders from the observer.

d. The agent corporal is the liaison agent for the platoon. He maintains liaison between the platoon and the unit which it supports or to which it is attached, or between the platoon and the company commander. He also assists the platoon leader in reconnaissance, and is trained to assume the duties of the instrument operator.

e. The instrument operator has charge of and operates the fire control instruments of the platoon. He assists the platoon leader in reconnaissance, preparing firing data, the search for targets, surveillance of the progress and safety of friendly troops, and fire control. He establishes platoon observation posts as directed, and assists in liaison duties.

f. The radiotelephone operator operates the platoon radiotelephone set and is responsible for the maintenance and operation of signal equipment within the platoon. He accompanies the platoon leader

and maintains communication with the company commander and the company command post.

g. The artillery mechanic performs and supervises such maintenance and service operations for the howitzers as may be performed by the using arm. He is furnished with tools and spare parts, which are usually transported on the ammunition truck.

h. The ammunition handler ordinarily remains with the platoon ammunition truck. He, assisted by the driver, loads and unloads ammunition. He assists the platoon sergeant in maintaining the supply of ammunition to the sections.

i. The messenger drives the ¼-ton truck assigned to platoon headquarters and is charged principally with the transmission of oral or written messages. He is responsible for driver maintenance of his vehicle and for its concealment and camouflage when halted. In addition, he will often act as a guide for the sections, operate telephones and other signal equipment, and act as an observer or liaison agent. He may also perform security missions when so directed.

j. The truck driver drives the platoon ammunition truck and trailer and is responsible for driver maintenance, concealment, and camouflage of his vehicle. He assists the platoon sergeant and the ammunition handler in supplying ammunition to the sections.

3. ARMAMENT. a. General. The armament of the cannon company includes crew-served and individual weapons.

(1) The crew-served weapons are the 105-mm howitzer, the antitank rocket launcher, and the caliber .50 machine gun.

(2) The individual weapons are the carbine and rifle.

b. Crew-served weapons.

(1) THE 105-MM HOWITZER. For a description of this weapon, see FM 23-105 and TM 9-326.

(2) ANTITANK ROCKETS, 2.36 INCH. (a) Rocket launchers and high explosive rockets are provided primarily for close-in protection against tanks

and other armored vehicles; secondary targets are crew-served weapons, embrasures, pillboxes, and grouped personnel. Ammunition must be conserved to insure effective use against primary targets.

(b) Rocket launchers, issued to the company on the basis of one to company headquarters and one to each platoon, are normally carried on organic transportation. For necessary assistance in loading and reloading, they are normally operated by teams of two men each. Four men per launcher are trained to fire the weapon. A practice rocket is provided for instruction in mechanical use, marksmanship, estimation of leads, and technique of fire. The rocket may be fired from the prone, standing, sitting, or kneeling positions; it may also be fired from the pit-foxhole and pit-type emplacements (figs. 5 and 6). (See also FM 23-30.)

(c) The rocket has a maximum range of 650 yards. It is reasonably accurate against moving targets at ranges up to 300 yards. In order to achieve surprise, fire against moving targets should be withheld until the last practicable moment.

(d) Higher-numbered cannoneers or other personnel not required for service of the piece will be designated as rocket teams by platoon leaders. They will normally function in their primary duties until a threat of mechanized attack becomes imminent or use against a secondary target is indicated. Timely warning must be received in order that rocket teams may secure their launchers and ammunition and move to their assigned positions (see par. 12). In both offensive and defensive combat, likely avenues of approach for armored vehicles should be reconnoitered and firing positions for rocket teams selected and prepared as soon as practicable after occupation of howitzer positions. Positions for rocket teams should be selected with particular attention to the necessity for protecting the howitzers against attack from the flanks and rear.

(3) MACHINE GUN, HB, CALIBER .50, M2, FLEXIBLE. A caliber .50 machine gun is mounted on the $\frac{1}{4}$ -ton truck in each platoon. Its primary use is the anti-aircraft defense of the platoon transport; its sec-

ondary use is the local protection of such transport from ground attack. All personnel are trained to fire the weapon. For conditions governing antiaircraft fire, see paragraph 13.

c. Individual weapons. (1) **CARBINES AND RIFLES.** These weapons are employed for the emergency defense and local protection of individuals, groups, howitzers, and company installations. When elements of the company are operating in exposed positions, it is imperative that additional riflemen be detailed for their close-in protection.

(2) **RIFLE GRENADES.** (a) The antitank rifle grenade is used against tanks and armored vehicles. (See FM 23-30.) This grenade is fired from such rifles and carbines in the company as are equipped with grenade launchers. Within its effective range, approximately 75 yards, this high explosive grenade is effective against all known light and medium tanks; it may also be used as an antipersonnel grenade, employing high-angle fire, at ranges up to 260 yards. With the use of the auxiliary grenade cartridge, ranges up to 380 yards are possible.

(b) The reconnaissance sergeant, communication sergeant, bugler, and messengers are each armed with a carbine and grenade launcher, and the automobile mechanic and truck drivers with a rifle and grenade launcher. Chiefs of section may utilize the truck drivers, when not required with the vehicles or engaged in their defense, to assist in protecting the howitzers and crews against mechanized attack.

(c) Pyrotechnic ground signals may also be fired from the grenade launchers. These signals are particularly valuable in acknowledging calls for delivering or lifting of supporting fires, in identifying a unit's location, and in air-ground liaison.

4. EQUIPMENT. For equipment of the cannon company, see Table of Organization and Equipment.

5. TRANSPORT. **a.** The company transport comprises the vehicles organically assigned to the company. These vehicles are used for command, commu-

nication, and maintenance; as prime movers; and for transportation of ammunition, equipment, and company personnel.

b. Whenever the terrain is suitable and hostile fires permit, howitzers and ammunition are moved by prime movers. When effective hostile fire prevents movement by vehicles, the howitzers and ammunition are moved for short distances, by hand. Individual arms, except those of truck drivers, are habitually carried by the individuals to whom assigned.

c. One truck and trailer of the transportation platoon, service company, are allotted to the company as the cannon company section of the regimental kitchen and baggage train.

Section II. TACTICAL EMPLOYMENT

6. CHARACTERISTICS. The cannon company is characterized by tactical mobility and flexibility of fires. Mobility results from the use of a prime mover permitting rapid movement of the howitzer over considerable distances; manhandling is practicable for short distances. Flexibility results from the howitzer's suitability for direct or indirect laying, for the engagement of targets at long or short ranges, and for the rapid shifting of fires. The proper exploitation of these capabilities necessitates adequate observation, careful selection of firing positions, and an efficient communication system.

7. MISSIONS. a. The general mission of the cannon company is to provide close and continuous fire support to the regiment. This is accomplished by the maintenance of close liaison with supported units, and the rapid delivery of fires, either on call or on the initiative of platoon or section observers, against hostile targets immediately opposing the regiment. Fire plans are coordinated with those of other supporting

Cannon Company functions at Regimental level much as the 81mm mortar platoon does at Battalion (see **FM 1-15**). Fire can be directed from company level using its own FO, who also handle calls for fire from the artillery; but any trained soldier can call for fire from Cannon Company.

weapons within the regiment and with the combat team artillery commander or the commander of the direct support artillery. The artillery commander is promptly notified of any changes in the plans or dispositions of the cannon company.

b. The company's weapons are employed primarily to destroy or neutralize hostile troops and weapons which at the time offer the greatest threat to the accomplishment of the regimental mission, and which cannot be engaged as readily by the supporting artillery. Exceptionally, units of the cannon company may engage area-type targets; however, artillery is usually employed against such targets, while cannon company elements are employed principally against point targets. Appropriate targets for the howitzers of the cannon company are automatic weapons, anti-tank guns, mortars, infantry howitzers, troop concentrations, road blocks, pillboxes, strongly fortified buildings, and armored vehicles. (See fig. 2.) Exceptionally, the company may be employed to supplement the antimechanized defense of the regiment or other supported unit. The cannon company commander coordinates with the regimental antitank officer (who is responsible to the regimental commander for the antimechanized defense of the regiment) in order that he may be informed of the antimechanized defense plans whenever cannon units are directed to supplement such defense. Because of the high trajectory and low muzzle velocity of the infantry howitzer, and the difficulties of tracking a moving vehicle, cannon units may best be employed during an enemy mechanized attack to destroy or neutralize tanks temporarily halted, or accompanying guns which are supporting advancing tanks.

c. The infantry howitzer is primarily a weapon of opportunity for prompt action against transient targets. It is not intended that it take the place of field artillery, but rather that it supplement, when necessary, the fires of other heavy weapons of the regiment.

Translation: The 105 projectiles take a while to get to the target, and a moving target is hard enough to hit with high muzzle velocity AT guns.

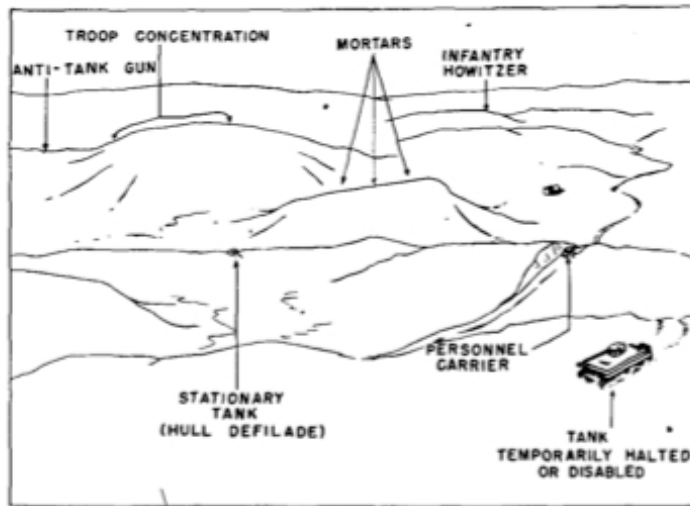

Figure 2. Appropriate targets for the infantry howitzer.

8. ASSIGNMENT OF COMPANY MISSIONS BY REGIMENTAL COMMANDER. The regimental commander assigns general missions to the cannon company and designates its initial position areas within the regimental zone of action or sector. Frequently, he will direct that each cannon platoon support a designated infantry unit. Exceptionally, he may direct that one or more cannon platoons be attached to an infantry unit or to an attached artillery unit. He anticipates, plans, and orders any changes required in the employment of the cannon company in order to meet changes in the tactical situation.

9. ASSIGNMENT OF PLATOON MISSIONS BY COMPANY COMMANDER. a. In accordance with the regimental commander's order, the company commander assigns each platoon its mission and initial position area, unless the platoon is attached to a sub-ordinate unit of the regiment.

b. A platoon may be directed to provide close support to a particular unit of the regiment. In this case, it is not usually assigned a sector of fire or target areas. However, if two platoons are assigned the mission of furnishing close support to the same unit, the company commander will ordinarily fix the responsibility of each platoon.

c. One or more platoons may be directed to support the action of the regiment as a whole. In such cases the company commander usually designates the unit of the regiment or the sector of fire (or target area) which will receive priority in supporting fires. The company commander may change this priority as the situation changes, or he may from time to time designate specific targets to be engaged.

d. The detailed fire control connected with the preparation and actual delivery of fire on a target is ordinarily exercised by platoon leaders or chiefs of section.

10. ORDERS OF COMPANY COMMANDER. a. Whenever possible, the company commander should personally issue orders to platoon leaders, or to each platoon leader individually, at a location from which terrain features referred to in the orders can be pointed out. Frequently, orders will be issued in fragmentary form.

b. The regimental zone of action, or sector, normally covers such a large area that it is rarely possible for the company commander to retain centralized control of all his platoons. In most situations, mission-type orders are issued to platoons furnishing close support to particular units of the regiment and, in some situations, to the platoon(s) supporting the action of the regiment as a whole.

c. Mission-type orders assign a definite mission to a subordinate unit, but leave some or all of the details of execution to the judgment of the unit leader. By issuing mission-type orders the company commander decentralizes control to the platoon leader. However, even when the company commander has issued such an order, he may restrict the platoon leader's freedom of action by prescribing some or all of the following details:

- (1) The earliest time or conditions for, opening fire.
- (2) Limits on ammunition expenditure.
- (3) Conditions under which displacements are to be made.

(4) The position area to which the platoon is to displace.

11. RECONNAISSANCE. a. General. Reconnaissance prior and subsequent to entry into combat is a responsibility of the company commander and platoon leaders. It must be timely, carefully planned, continuous and progressive throughout the action, and so conducted as to take full advantage of cover and concealment.

b. Initiation of reconnaissance. Upon receipt of the regimental field order, or on the basis of prior instructions of the regimental commander, the company commander should analyze all parts of the order or instructions which affect the cannon company; briefly consult with other appropriate officers concerning details of cooperation and fire support; plan the reconnaissance; issue early instructions for any preparatory movement or dispositions of the company; and inform the second-in-command or the senior platoon leader, of his route of reconnaissance and the place and time subordinates are to assemble to receive the company field order, if such assembly is practicable. Platoon leaders take similar steps upon receipt of the company order, or, if attached to a unit, the order of the unit commander.

c. Examination of terrain. Reconnaissance executed by cannon company personnel includes the examination of the terrain for locations of observation posts; locations of initial and subsequent position areas as well as primary, supplementary, and alternate howitzer positions and routes thereto; locations of targets or of areas in which targets are likely to appear; locations of elements of other supporting units and of nearby friendly troops and installations; locations of command posts, communication routes, and initial and subsequent ammunition supply points.

Section III. PROTECTIVE MEASURES

12. WARNING SYSTEM. a. General. The regimental antiaircraft-antimechanized warning system includes an intelligence system and a signal communication system, both coordinated to insure early and continuing information of the presence and action of hostile air, armored, and motorized forces. (See FM 7-40.)

b. Regimental antiaircraft-antimechanized warning system. (1) The regimental S-2 is responsible for the establishment and supervision of the regimental warning system, and for its coordination with the observation system of the supporting artillery and the warning systems of adjacent and higher units.

(2) The regimental warning system includes all reconnaissance and security detachments operating under regimental control, all observation facilities within the regiment, and air-antitank guards equipped with means for giving the alarm. All elements in the system make immediate report of air and mechanized threats by the most expeditious means available. All warning messages are classified as urgent.

c. Local warning systems. Air units and motor reconnaissance elements usually give the first warning of the presence of hostile tanks in the vicinity of the regiment. However, the cannon company commander is responsible that an effective local warning system is constantly in operation within the company. He insures that air-antitank guards are posted by each section and that warnings received from the regimental warning system and from such guards are promptly transmitted to all elements of the company.

d. Warning signals. To give warning of the approach or presence of hostile aircraft or mechanized vehicles, the following standard warning signal is prescribed: three long blasts of a whistle, vehicular horn, siren, or klaxon, repeated several times; or three equally spaced shots with a rifle, carbine, or pistol; or three short bursts of fire from an automatic weapon. In daylight, the individual giving the signal indicates,

by pointing, the direction of the impending danger. At night, the alarm signal will be supplemented by voice to indicate the direction. In addition to the standard signals, other available means, such as radio and pyrotechnics, may be employed.

13. ACTION IN CASE OF AIR ATTACK.

a. Regardless of the effectiveness of the security measures taken by higher command through the offensive action of combat aviation, all units must consider the probability of air attack and reconnaissance, and employ appropriate security measures. Passive measures include dispersion, concealment, and camouflage. Active measures comprise firing at attacking airplanes.

b. Fire will not be delivered on any aircraft unless it is clearly recognized or positively identified as hostile, or unless it attacks with bombs or gunfire. Concealment and camouflage are used whenever possible to prevent detection. If concealment is believed to have been achieved, no weapons are fired at approaching enemy aircraft.

e. (1) On the march, upon receipt of warning of hostile air attack, prime movers and other vehicles are driven off the road ; whenever terrain and time permit, they are driven off the road far enough to clear the probable impact area. Maximum use is made of any available cover and concealment. All men, except those designated as crews for the caliber .50 machine guns, dismount and take cover, but remain close enough to their vehicles to resume movement as soon as the attack has passed.

(2) In other situations, upon warning of air attack, personnel of the cannon company disperse and take cover.

(3) Caliber .50 machine guns and individuals armed with rifles and carbines open fire upon attacking planes only upon command or prearranged signal of the company commander or responsible unit leader, as soon as the planes are within effective range.

14. CLOSE-IN DEFENSE AGAINST MECHANIZED ATTACK. Elements of the cannon company must be continually prepared to defend themselves against mechanized attack by the fires of the howitzers and employment of antitank rifle grenades and rockets provided for this purpose. If tanks succeed in approaching within 300 yards of a howitzer position, personnel not engaged in operating and serving the howitzer, or in firing at accompanying foot troops, employ rockets and individual weapons against the tanks. Doors and turrets, if open, offer particularly favorable targets to small-arms fire, as do also vision slits and periscopes. Should tanks succeed in approaching close enough to warrant such action, incendiary grenades, antitank bombs, and smoke grenades may be used. Personnel forced to take cover to avoid the crushing action of tanks return to their firing positions as soon as the tanks have passed and continue their fire on these vehicles or on other approaching tanks or accompanying infantry.

15. INDIVIDUAL PROTECTION. a. Full advantage should be taken of available cover and concealment, both while in movement and while halted.

b. Whenever troops are halted in a combat zone, individual protection will be sought and improved, or excavated. When the halt is expected to be brief, troops will take advantage of such natural protection as is afforded by the terrain. When the halt is expected to be for a longer period, as, for example, a halt in an assembly area, foxholes will be dug. Full advantage will be taken of natural cover and concealment in the construction of foxholes.

16. EMPLACEMENTS. Emplacements for howitzers and rocket launchers are dug and concealed whenever time permits.

a. Howitzer. The emplacement for the howitzer (fig. 3) is a circular pit with parapet, and permits all-around fire. A ramp for the movement of the weapon into and out of the emplacement is dug to the rear. One or more ammunition shelters are dug in the forward wall of the pit deep enough to be secure against surface explosions. Foxholes for members of the crew

are dug in the immediate vicinity of the emplacement. The circular type emplacement can be developed from a hastily-prepared shallow gun pit, in which the spoil is thrown up as a frontal parapet only (fig. 4).

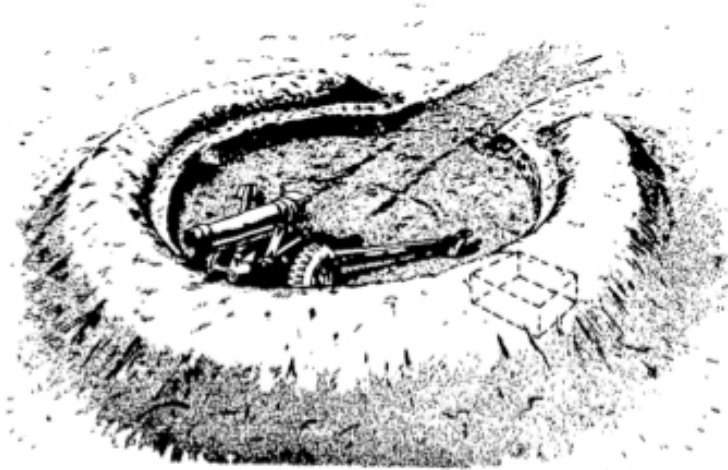

Figure 3. Circular emplacement for howitzer. The pit is 19 feet in diameter and 2 feet deep. In this and succeeding figures of emplacements the camouflage net is omitted for purposes of clarity.

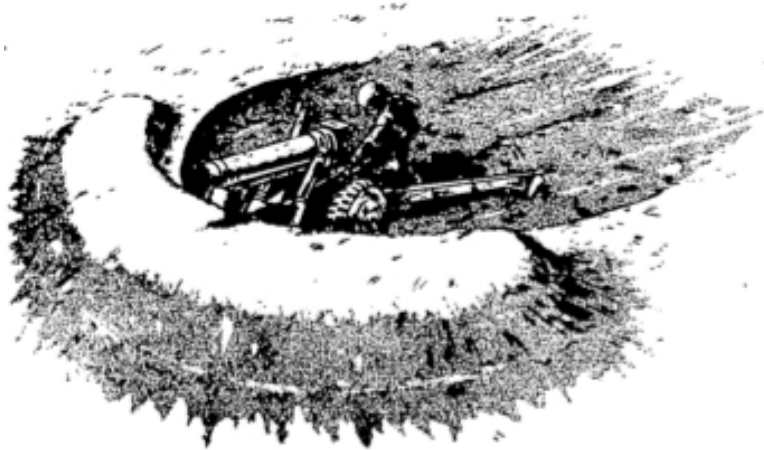

Figure 4. Development of circular emplacement for howitzer.

b. Rocket launcher. The two types of emplacement for the rocket launcher are the pit-foxhole type and the pit type.

(1) **PIT-FOXHOLE TYPE** (fig. 5). This emplacement is a circular pit, with parapet, 3 feet in diameter and about 3 ½ feet deep. It is large enough for two

men. It permits the assistant rocket gunner to rotate as the rocket gunner traverses the weapon so that the former may avoid being in rear of the weapon when it is fired. Its depth is such that the rear end of the rocket launcher at maximum elevation in any direction will be clear of the parapet, thus insuring that the back blast from the rocket will not be deflected into the emplacement and burn the occupants. Except in firm soil, this requirement can be met only by an emplacement which is too shallow to give protection against the crushing action of tanks; in such a case, foxholes for the rocket gunner and assistant rocket gunner are dug nearby. As the antitank mission of the rocket launcher requires that it be kept in action against hostile tanks until the last possible moment, these foxholes will be occupied only as a last resort when a tank is about to overrun the emplacement.

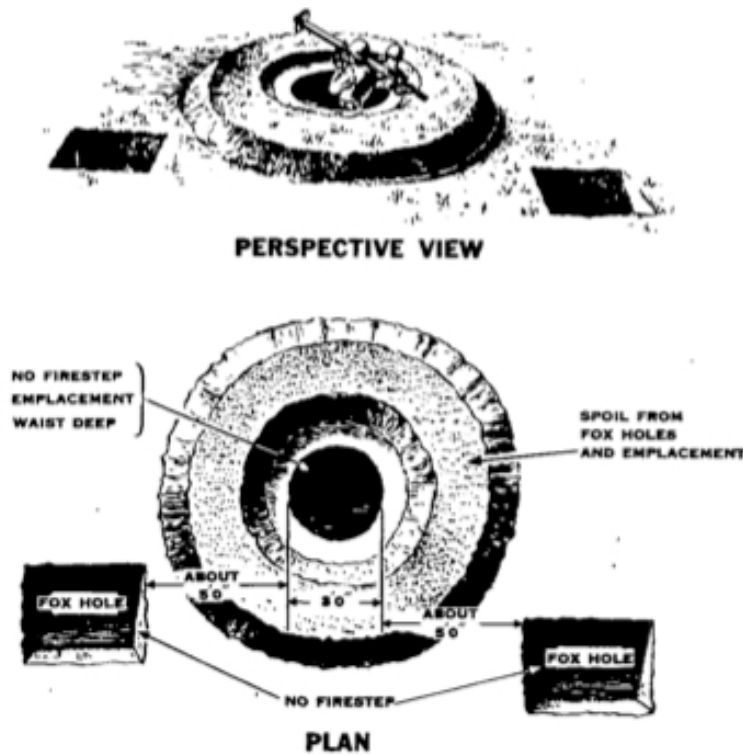

Figure 5. Pit-foxhole type emplacement for rocket launcher.

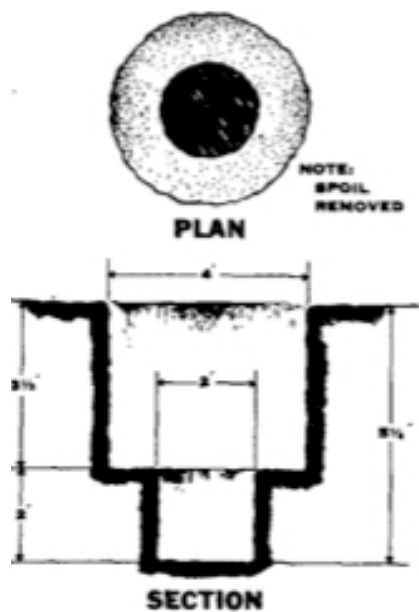

Figure 6. Pit-type emplacement for rocket launcher.

(2) PIT TYPE (fig. 6). In firm soil, the pit of the pit-foxhole type emplacement can be enlarged from 3 to 4 feet in diameter, with an additional circular pit 2 feet deep and 2 feet in diameter excavated in the center. This provides a circular fire step 1 foot wide and about 3 1/2 feet below the surface. When tanks appear about to overrun the position, the rocket gunner and assistant rocket gunner crouch with the rocket

launcher in the lower pit. When the tanks have passed, the rocket launcher is promptly returned to action.

17. CONCEALMENT AND CAMOUFLAGE. a. Concealment and camouflage are of prime importance in constructing defensive works. Measures for concealment from aerial observation must be planned from the beginning and maintained continuously. From both the area to be excavated and that on which spoil is to be piled to form a parapet, all turf, sod, leaves, or forest humus are removed carefully, set aside, and replaced over the spoil when the emplacement is finally completed.

b. In order to prevent discovery of the work during the process of excavation of howitzer emplacements, garnished camouflage nets should be suspended from stakes or trees *before* any excavation is undertaken. Excavation should be confined to the area beneath the camouflage net. The net is suspended at such a height above the ground as to permit the workers to excavate the emplacement without snagging equipment or intrenching tools on the net. After the excavation has been completed and the spoil covered with sod or other natural camouflage material, the net should be lowered close to the ground so as to be inconspicuous from ground observation. Nets are kept in position so as to conceal the emplacement when the weapon is not being fired. Arrangements must be made to lift or withdraw the net during action in order not to interfere with firing.

c. Personnel, weapons, and equipment are camouflaged whenever this will assist in concealing them from the enemy, or misleading him as to their true nature.

Chapter 2

SUPPLY, MEDICAL SERVICE, AND EVACUATION

Section I. SUPPLY

18. RESPONSIBILITY. Supply is a responsibility of command which cannot be delegated. The company is the basic unit with administrative functions. The company commander is responsible for the initial supply and, except as indicated below, the replenishment of all classes of supply to the company and any attached units. Requisitions must be forwarded sufficiently in advance to enable the regimental supply officer to make supplies available for distribution in time to meet the requirements of the company.

19. MEANS. a. To effect supply, the company commander is assisted by the supply sergeant, transportation sergeant, mess sergeant, armorer-artificer, and such additional personnel as he may designate. (See par. 1.)

b. Transportation for supplying the company other than by organic company vehicles is furnished by the regimental train.

20. CLASS I, II, III, AND IV SUPPLY. a. Definitions and methods. For definitions and methods relating to class I, II, III, and IV supply, see FM 7-30.

b. Feeding of distant elements of the company. When elements of the company are employed at a considerable distance from the company mess location, it will often be impracticable for them to be fed by their own company. In such instances, they will be fed either by the units to which they are attached, or, if not attached, by nearby supported or other units. In

either instance, the cannon company commander will insure, by careful planning and coordination with the regimental S-4 and appropriate commanders, that men are fed adequately and on time. If, through lack of time, or for any other reason, it is impracticable to establish such measures in advance, leaders of cannon company elements attached to or supporting other units will themselves contact the commanders of these units, and insure that their personnel are fed.

21. CLASS V SUPPLY. a. General. (1) Class V supplies include all classes of ammunition, antitank mines, chemicals, antitank rockets, grenades, and pyrotechnics.

(2) Sufficient howitzer ammunition to enable the cannon company to initiate combat is carried for each howitzer on its prime mover and on platoon ammunition vehicles. Ammunition for other weapons within the company is carried by individual soldiers, on prime movers, and on platoon and company headquarters vehicles.

b. Replenishment during offensive combat.

(1) During route marches the platoon vehicles usually move under control of the company commander with the regimental motor column, as directed by the regimental commander. When combat is imminent, these vehicles are released to platoons. During combat, platoon ammunition vehicles usually remain under platoon control and are held in platoon position areas as close to the firing positions as the terrain permits, except when engaged in the resupply of ammunition, or when control is reassumed by the company commander. Section prime movers are refilled from platoon ammunition trucks or from platoon reserves established in the vicinity of the platoon or section firing positions. When a platoon ammunition truck is emptied, the trailer (with a full load of ammunition) may be kept in the platoon position area, and the emptied truck dispatched by the platoon leader to the company ammunition supply point.

(2) When the situation warrants, the platoon $\frac{1}{4}$ -ton truck may be used in replenishing the supply of a

section. This truck may also be used to tow the ammunition trailer for short distances.

(3) The company commander is responsible for the initial supply and resupply of ammunition for the company, except when a platoon is attached to a unit operating separately from the regiment, in which case the commander of that unit is responsible. He maintains a record of ammunition expenditure to insure continuous accurate information as to the status of ammunition supply within the company. He selects and establishes the company ammunition supply point. (See g, below.) He may also assume control of platoon ammunition vehicles at any time. When a platoon is confronted with emergency ammunition requirements or has lost an ammunition vehicle, the company commander may divert ammunition to such platoon from another platoon whose ammunition requirements are less pressing.

(4) When an emptied platoon ammunition vehicle reports to the company ammunition supply point, it is directed or conducted to the regimental ammunition supply point. (See fig. 7.) At this point ammunition may be replenished by refilling the vehicle from a reserve which has been dumped previously, or by exchange of the emptied vehicle for a filled one. If no ammunition is available at the regimental ammunition supply point, the emptied vehicle may be conducted to the army ammunition supply point under regimental control, refilled, returned to the regimental ammunition supply point, and released with all or part of its load to the platoon from which it was dispatched.

(5) The regimental commander is responsible for making howitzer ammunition available at the regimental ammunition supply point in adequate amounts for the replenishment of the platoons of the cannon company. Procurement of this ammunition is effected by the use of available regimental train vehicles and cannon platoon ammunition vehicles.

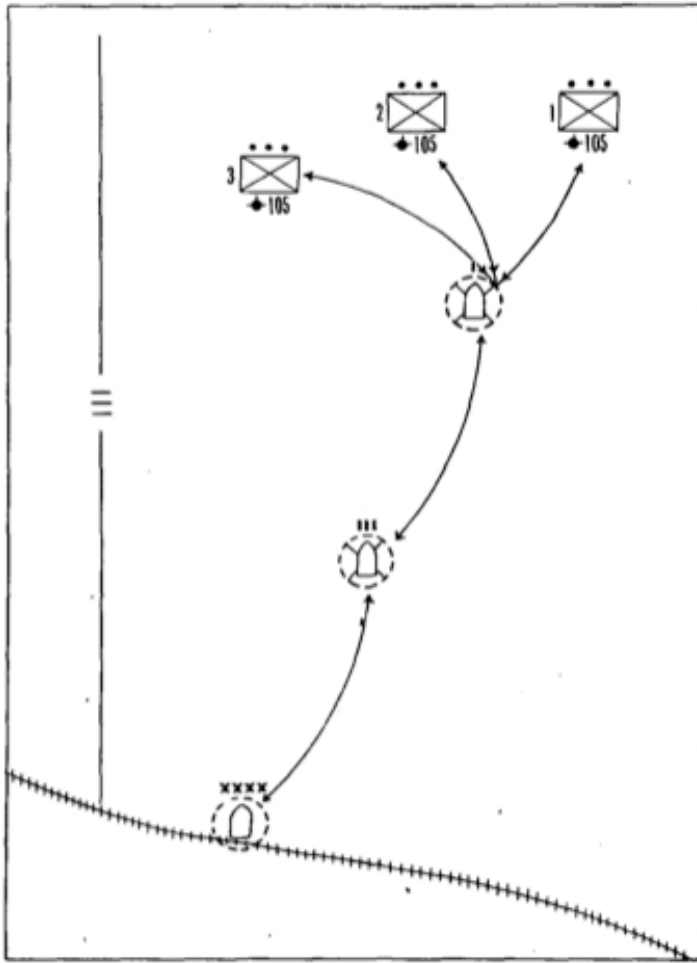

Figure 7. Ammunition supply. (Schematic) Platoon ammunition vehicles are routed through the company ammunition supply point to the regimental ammunition supply point, where they are either refilled, exchanged for filled vehicles, or dispatched to the army ammunition supply point for refill.

(6) The tonnage involved in the supply of ammunition for the cannon company is so great that requirements must be anticipated. When the regiment develops for combat, the munitions officer, on the basis of recommendations of the cannon company commander, takes the necessary steps to establish a reserve of ammunition for release to the platoons of the cannon company. When a loaded vehicle is available at the regimental ammunition supply point, it is dispatched to the platoon from which an empty pla-

toon vehicle reports. When the regiment uses vehicles other than those assigned to cannon platoons for hauling howitzer ammunition from the army ammunition supply point, these vehicles are usually released to the cannon company commander until their loads have been distributed in order to avoid transloading.

High Explosive (HE) ammo is sensitive, and loading and unloading should be minimized.

(7) When a platoon is attached to a battalion operating separately from the regiment, its emptied ammunition vehicles are dispatched for refill to the battalion ammunition supply point or to the cannon company ammunition supply point, whichever offers the greatest facility for resupply.

c. Replenishment during defensive operations.

(1) In the defense, platoon ammunition vehicles will be employed for the establishment of small dispersed section or platoon ammunition reserves dumped in concealed and defiladed locations close to and readily accessible to the firing positions of the howitzers.

(2) After ammunition has been dumped, platoon ammunition vehicles revert to control of the company commander, at which time they are dispatched to the regimental ammunition supply point for refill. Since it will be exceptional for the regiment to have a resupply of howitzer ammunition available at the beginning of any operation, these vehicles generally will be dispatched under regimental control to the army ammunition supply point. Upon return to the regimental ammunition supply point, they will be released to the control of the company commander. The number of trips necessary will be determined by the amount of ammunition to be placed on the position. After the required amount of ammunition has been placed on the position, the platoon ammunition vehicles will be refilled, and guided or conducted to the regimental train bivouac. The ammunition on these vehicles will then constitute a part of the regimental mobile ammunition reserve.

d. Replenishment during rapidly moving situations. In a rapid forward movement, such as with an advance guard or in pursuit, the system of ammunition supply is similar to that in attack. When distances

from army ammunition supply points are so great as to make replenishment difficult, requirements are determined and additional quantities of ammunition and transportation secured from higher headquarters.

e. Replenishment in retrograde movements. During retrograde movements, sufficient amounts of ammunition for the contemplated action are retained with each unit. Resupply may be effected by releasing regimental ammunition carrying vehicles to the platoons on rear positions or by the establishment of reserves by higher headquarters on rearward positions or enroute thereto. The regimental commander will inform the company commander as to the location of such reserves.

f. Records and reports. (1) An accurate record of expenditures and receipts of howitzer ammunition will be maintained at all times as follows:

(a) By the chief of section.

(b) By the platoon sergeant under the supervision of the platoon leader.

(c) By the supply sergeant under supervision of the company commander.

(2) Platoon leaders will render daily reports to the company commander. The company commander will make a daily ammunition report to the regimental commander.

g. Company ammunition supply point. (1) The company ammunition supply point is selected and established by the company commander. It may be located near the company command post in order to take advantage of the company communication net. Vehicles proceeding to and from the company ammunition supply point will be routed so as to avoid passing close to the company command post. Desirable characteristics of a company ammunition supply point are:

(a) Location at or in rear of the point where covered routes diverge to platoons.

(b) Facility of motor movement to the rear.

(c) Concealment from air and ground observation.

- (d) Defilade from enemy flat-trajectory fire.
 - (e) Difficulty of enemy identification by day or night.
 - (f) Ease of identification for friendly troops.
- (2) The company ammunition supply point is operated by the supply sergeant or other personnel designated by the company commander.

Section II. MEDICAL SERVICE AND EVACUATION

22. REGIMENTAL MEDICAL DETACHMENT. For composition and duties of the regimental medical detachment, see Table of Organization and Equipment and **FM 7-30**.

23. AID STATIONS. a. Elements of the cannon company utilize the aid stations of battalions in whose areas they are operating. If not operating in battalion areas, they utilize the regimental or nearest battalion aid station,

b. At the beginning of an action, the cannon company commander contacts the regimental surgeon to insure a clear understanding as to which aid stations are to be utilized by the elements of the company; thereafter, he keeps the surgeon informed of changes in the location of these elements, since such changes may require corresponding changes in designation of aid stations which they are to utilize.

24. COMPANY AID MEN AND LITTER BEARERS. a.
Company aid men. The three Medical Department enlisted men serving with the cannon company are known as company aid men. They are attached to the company when it is on the march, in bivouac, and in combat, and may in turn be attached to platoons of the company. Each of these men carries two pouches containing medical equipment such as bandages, dressings, tourniquets, etc.

Their duties are:

- (1) To administer emergency treatment when needed.
- (2) To maintain contact with the cannon company.
- (3) To inform walking sick and wounded of the route

to, and the exact location of, the battalion or regimental aid station.

(4) To send information to the aid stations by litter bearers and walking wounded. This information includes the location of cannon company elements and the approximate number and location of casualties in the areas occupied by such elements.

(5) To place all seriously wounded in defilade locations along the axis of advance.

b. Litter bearers. Leaders of cannon elements desiring litter evacuation of wounded personnel contact appropriate aid stations and request such evacuation.

25. ORDERS. The cannon company order will include the designation and locations of aid stations to which casualties will be evacuated. All members of the company will be informed of these designations and locations. If, during the course of the action, the casualties of any element of the company are to be evacuated to a different aid station from that originally announced, or any other changes in the system of evacuation are to be made, the company commander issues the necessary additional instructions.

26. SANITATION. The cannon company commander is responsible for the sanitation within his company and the area which the company occupies. He is also responsible for the formation of an antimalaria detail, to consist of a minimum of two enlisted men, including a noncommissioned officer. The detail will be made up of nonmedical personnel, and will be trained and will function as outlined in War Department directives. Medical Department personnel act as advisers in the technical aspects of sanitation and malaria control.

Chapter 3

MARCHES AND BIVOUACS

Section I. MARCHES

27. ROUTE MARCH. In the route march, the cannon company, less any detachments on security missions, normally marches well forward in the regimental motor column. The company commander, together with the reconnaissance sergeant, communication sergeant, a radiotelephone operator, and messenger, usually accompanies the regimental command group. The reconnaissance officer (second-in command) conducts the march of the company (less detachments). Contact is maintained between the company commander and the reconnaissance officer by radiotelephone or motor messenger.

28. ADVANCE GUARD. a. Elements of the cannon company may be attached to the regimental advance guard. (See **FM 7-20**.) Ordinarily not more than one cannon platoon is attached to an advance guard consisting of one battalion. During the march, the platoon leader, together with the agent corporal, radiotelephone operator, and messenger, usually accompanies the advance guard commander. He is responsible for continuous reconnaissance for the selection of firing position areas, observation posts, and routes thereto. He is frequently assisted in this reconnaissance by a detail (reconnaissance sergeant and one or more messengers) from the company command group; this detail is also employed to guide the sections into successive position areas. In addition, the company com-

mander will usually furnish the platoon leader with additional transportation and communication facilities (particularly radiotelephones), to assist in reconnaissance and in controlling the fire of the platoon.

b. The platoon advances by bounds in the interval between the rear of the advance guard and the head of the main body. Its movement is supervised by the platoon sergeant, who maintains communication with the platoon leader by radiotelephone or motor messenger.

c. As soon as the advance guard encounters enemy resistance which is apparently of sufficient strength to warrant the employment of the howitzers, the platoon leader directs the platoon to occupy selected firing positions. Guided by members of the reconnaissance detail, the platoon then moves into position and executes any required fire missions.

29. FLANK GUARD. a. A flank guard consisting of an infantry battalion is usually the smallest unit to which a cannon platoon is attached.

b. A cannon platoon attached to a flank guard moves by bounds to successive firing position areas, prepared to furnish close support in the accomplishment of the flank guard mission.

30. REAR GUARD. a. As part of an advancing force. Elements of the company are not normally employed to reinforce the rear guard of an advancing force.

b. As part of a retiring force. (1) Cannon company units are well suited for reinforcing the rear guard of a retiring force. (See **FM 7-20.**) Depending upon the strength and composition of the rear guard, one or more cannon platoons may be attached thereto.

(2) Howitzers are employed from positions permitting long-range fires and affording covered routes of withdrawal. The primary mission of cannon company units attached to a rear guard is to slow down the enemy pursuit. Fire is opened at long ranges and may frequently be used to cover road blocks and other obstacles. Withdrawal to successive positions

will be made in accordance with instructions from the rear guard commander; the withdrawal being timed, first, on the rate of withdrawal of the main body, and second, on the rate of advance of the enemy force. Close combat is avoided whenever the main body retires rapidly enough to make this possible.

Section II. BIVOUACS

31. BIVOUAC. a. The regimental commander assigns an area for the bivouac of the company. The company commander in turn allots portions of the area to the respective platoons and designates the location of the command group. Chief reliance for anti-aircraft security in bivouac is placed upon concealment and the digging of foxholes for individual protection; advantage is taken of all natural protection afforded by the terrain.

b. Elements of the company may be attached to the bivouac outpost established by the regimental commander. The cannon company, less any elements attached to the outpost, is located so as to permit the delivery of effective defensive fires and to supplement the antitank defense of the bivouac area.

Chapter 4

OFFENSIVE COMBAT

Section I. APPROACH MARCH AND ASSEMBLY AREA

32. APPROACH MARCH. a. From route march the cannon company enters the approach march as directed by the regimental commander. (See FM 7-40.) His development order prescribes the march objective, or the successive march objectives; the zone or axis of advance; the base unit (if any), and the units to be supported by the cannon company or elements thereof. The cannon company, less units attached to or assigned missions of supporting the leading battalion(s), usually moves by bounds in rear of the foot elements of the regiment, available for prompt employment as the situation develops.

b. A night approach march is executed at reduced distances along routes which have been reconnoitered and marked in daylight. The cannon company usually marches as a unit with the regimental motor elements.

33. ASSEMBLY AREA. During occupation of an assembly area, elements of the cannon company may be attached to, or placed in support of the covering force, while the remainder of the company usually is assigned the mission of supplementing the antimechanized defense of the area.

Section II. EMPLOYMENT IN THE ATTACK

34. MISSIONS. a. The howitzers of the cannon company are employed principally against targets imme-

diately opposing the advance of supported units. Targets may also include those within effective range in rear of enemy front-line elements or in adjacent zones of action.

b. Exceptionally, the cannon company may be assigned the mission of supplementing artillery preparatory fires. Determining factors which may justify such a mission are:

(1) An existing deficiency in artillery support.

(2) The ability of the cannon company to provide its normal close supporting fires to the attacking battalion(s) at the proper time..

(3) The availability of an extra supply of ammunition at the positions from which the preparatory fires are to be delivered, thus insuring to the platoons their full organic supply of ammunition for the subsequent accomplishment of their normal missions.

c. When tanks are attached to an infantry regiment or are operating in its zone of action, the cannon company may be employed principally to destroy enemy antitank guns discovered during the attack. For employment of artillery in support of infantry-tank action and support of tank attack by infantry, see FM 17-36.

35. RECONNAISSANCE PRIOR TO ATTACK.

Prior to the attack, the regimental commander may direct the company commander to accompany him on reconnaissance or to meet him at a designated time and place, prepared to submit recommendations for the employment of the company. (See par. 11.)

36. LOCATION OF PLATOON POSITION AREAS.

a. The position area assigned to each of the cannon platoons usually should be well forward, near observation, and yet not so far forward as to involve undue exposure. (See fig. 8.) Such position areas must permit the selection of firing positions from which fire can be placed on all assigned targets, sectors of fire or target areas. In general, suitable firing positions can usually be found between battalion and regimental re-

serves. Whenever practicable, firing positions should permit concentration of the fires of both howitzers of the platoon on a single target.

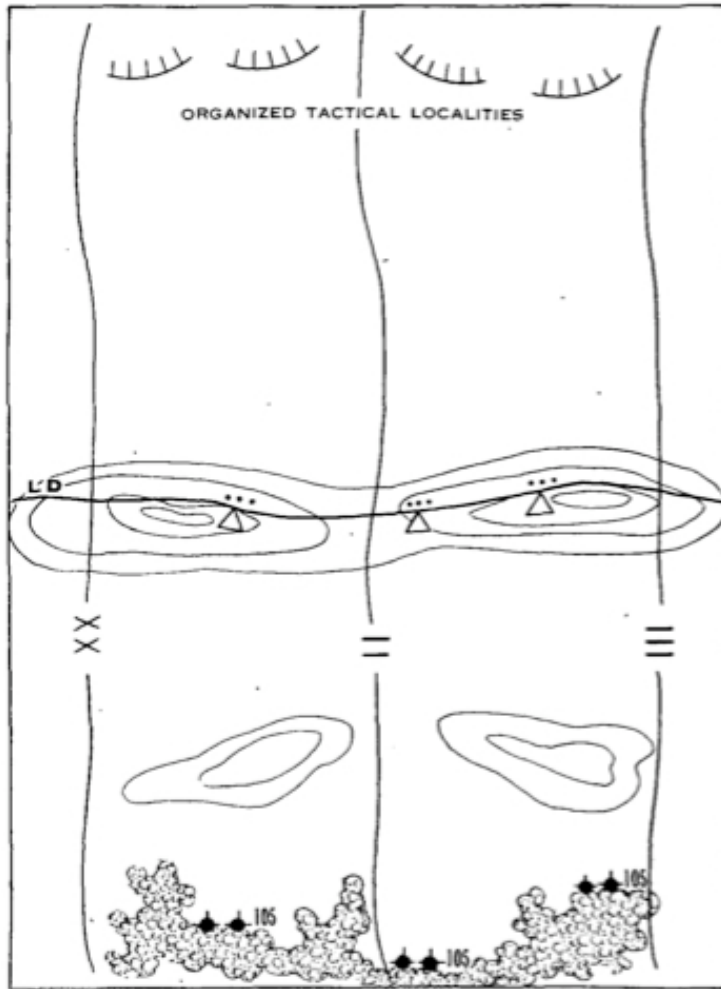

Figure 8. Initial support of an attack. (Schematic)

b. The position area assigned each platoon should provide cover from flat-trajectory fire and, if possible, concealment from aerial observation for howitzers, crews, and vehicles.

c. Suitable sites for observation posts must be available for the conduct of fire and for observation of the advance of friendly troops. Observation posts must be located so that adequate and continuous communication may be maintained with the firing positions. Normally, such communication will be by telephone within each platoon.

37. CONDUCT OF THE ATTACK. a. During the attack, one cannon platoon is usually directed to follow and provide close support to each forward battalion, while the remainder of the company, (if any) is placed in support of the regiment as a whole. To support the initial phase of the attack, each platoon is normally placed in a defiladed firing position from which fires may be delivered into any part of the zone of action of the supported unit.

b. In order to assure continuing close support of the attacking rifle units, the platoon leader, when the progress of the attack warrants, prepares for the forward displacement of his platoon. The company commander may order the displacement or may delegate this decision to the platoon leader. In either case, the platoon leader plans ahead for the timely displacement of the platoon by constant observation of the progress of supported units, by close liaison with the company commander, and by reconnaissance to the front, executed by the platoon leader himself or by designated personnel from the platoon or company command group. Displacement by platoon is normal.

c. During the attack, the company commander remains with the regimental commander, except when combat duties require his presence elsewhere. During such absence he designates his reconnaissance officer or other available member of the command group to maintain liaison with the regimental commander and the combat team or direct support artillery commander. Similarly, a platoon leader maintains liaison with the commander and artillery liaison officer of the unit which his platoon is supporting or to which it is attached, or with the cannon company commander when the platoon is supporting the regiment as a whole. Such liaison is maintained by the platoon leader personally or by directing the agent corporal to perform this duty.

d. During the progress of the attack, cannon elements engage appropriate targets on call from supported units or on the initiative of cannon observers.

Section III. SPECIAL OPERATIONS

38. ATTACK IN WOODS. a. The conduct of the attack against the near edge of a woods is similar in its early stages to that described in paragraph 37. Howitzer fires are delivered against hostile supporting weapons located in the near and lateral edges. Special attention is devoted to the destruction or neutralization of enemy automatic weapons located outside the woods in positions from which flanking fires can be delivered against the attacking forces.

b. The effective employment of the howitzers of the cannon company in woods is limited by the following factors: difficulty in maintaining direction, contact, and control; short and obstructed fields of fire; scarcity of suitable routes for the movement of vehicles; lack of adequate observation; difficulty of adjusting fire on targets without endangering friendly troops; difficulty of ammunition supply; and vulnerability of howitzers to by-passed enemy ground elements.

c. Every effort should be made to locate successive firing positions affording adequate mask clearance for the howitzers. Such positions may be found in the edges of existing clearings while, at times, it may be necessary to clear openings from which fires can be delivered. At other times, the action of howitzers may be restricted to the delivery of direct fires across clearings or along roads and trails for the engagement of targets of opportunity.

d. During the advance through the woods, elements of the cannon company may be attached to designated infantry units in order to facilitate control and to insure local protection of the cannon units by rifle troops.

e. The exit from the woods, and the continuance of the attack is conducted generally as an attack in any other open terrain. Since the edge of the woods is a favorable target for enemy artillery, cannon company howitzers should be emplaced as far within the

woods as is practicable, and should displace rapidly to new positions outside the woods as soon as the tactical situation permits.

39. ATTACK OF TOWNS. a. In the attack of towns, a large proportion of the supporting weapons of an infantry regiment will ordinarily be attached to battalions. (See FM 31-50.) The determining factor in the decision will be whether control and close support can best be obtained by such attachment. Steps must be taken to insure that the attached weapons are provided with close- in rifle protection.

b. The employment of the cannon company during the attack of the near edge of a town and during the exit from the town, is similar to that described for an attack in woods and the exit therefrom.

c. During the advance toward the town, howitzer fires are delivered against the near edge, with particular attention to enemy automatic weapons occupying positions which permit flanking fires. Concentrations of fire are also placed on predetermined key points of the hostile defenses within the town, thereby neutralizing or destroying enemy supporting weapons and emplacements and driving enemy troops into dug-outs and other shelters. The howitzers will also be prepared to deliver fires to the flanks of the attacking force for protection against enveloping counterattacks by enemy reserve units. Fires are lifted on prearranged signals or other means of communication. Cannon units displace promptly in order to continue their close support of the leading friendly elements.

d. Within the town, neutralization of hostile fire is of paramount importance. Due to the proximity of forces in fighting within built-up areas, much of the close fire support will be furnished by infantry cannon, using direct fire. Howitzers furnishing such close support deliver fires to destroy or neutralize emplaced automatic weapons, strongly fortified buildings, and stationary or slowly-moving armored vehicles. They may also employ high-trajectory fire against targets sheltered behind distant buildings. Because of its low silhouette, the howitzer may take advantage of cover afforded by the walls of partially

demolished buildings or piles of debris. Fields of fire and observation are obtained along streets or across open areas such as parks and squares. Observation may also be obtained from upper stories or roofs of buildings. Control and the provision of close support will often be facilitated by the attachment to design of such cannon platoons or sections as were not attached to battalions prior to the attack of the near edge of the town. In order to afford protection from attack by enemy groups which may have been by-passed during the advance through the town, local security for howitzers and crews should be provided by friendly riflemen.

40. ATTACK OF A RIVER LINE. a. In supporting the attack of a river line during daylight, such preparations as are possible in the time available, and as can be concealed from enemy observation, are completed on the day of the attack.

b. If the crossing is to be made at or just before dawn, all preparations, except the forward movement of weapons, are completed during daylight of the previous day. Howitzers are moved into firing positions immediately prior to the hour of attack, but do not open fire until the attack is discovered, and then only upon appropriate targets. (See par. 7.) Cannon company elements are placed as near the river as possible in order to cover effectively the principal crossing, but not so far forward that the noise made by the prime movers destroys the element of surprise. Position areas and observation posts are located with particular reference to the actual or probable locations of enemy supporting weapons, reserves, and observation posts on the far side of the river.

c. The wide crossing front of the regiment frequently requires wide separation of cannon platoons, and precludes effective control by the company commander. This difficulty is offset by the issuance of mission-type orders to platoons to provide close support to designated units, or by the attachment of cannon platoons to leading infantry battalions. Orders and instructions are issued in minute detail.

d. Reconnaissance elements of the company cross

the river with the attacking echelon. Howitzers should be transported across the stream as soon as the attacking echelon has seized the first objective. This objective is a position the occupation of which will secure the crossing against effective direct small-arms fire. (See **FM 7-40.**) When ponton ferries or bridges are not in operation, howitzers may frequently be crossed by improvised means. (See Appendix I.)

e. After the crossing is effected, the howitzers provide close support to infantry units during the advance to the second objective. If attached to infantry units, they remain attached until the second objective is captured, at which time they usually revert to company control and support the attack against the next objective as in any other coordinated attack.

f. Throughout the crossing, one platoon is usually held under company control in support of the regiment as a whole. After this platoon has crossed, its primary mission is to engage targets in the zone of action of the battalion making the main effort.

g. At the time of crossing, howitzers must have full organic loads of ammunition on prime movers; provision for early replenishment must be made in advance.

41. ATTACK OF A FORTIFIED POSITION. a. When the isolation of a fortified position by an initial enveloping maneuver is impossible, it must be reduced by a direct attack against a weak point. The attack may be divided -generally into four phases:

(1) Reducing the enemy outpost system and developing the main position.

(2) Breaking through the fortifications at the most favorable point.

(3) Extending the gap by isolating and reducing hostile emplacements on its flanks.

(4) Completing the action by moving mobile reserves through the gap to complete the encirclement and isolation of the remaining emplacements, while continuing the attack against them from the front. (See **FM 31-50.**)

b. In the attack against a fortified position, assault battalions are usually reinforced. Each assault infantry battalion may include cannon company elements which are employed to provide close support to the attack. Each weapon is initially given a specific mission.

c. The indirect-fire missions of the cannon company include destruction or neutralization of supporting weapons in areas between fortified emplacements, and interference with movements of hostile reserves. By using smoke shell, cannon company howitzers may also be employed at times for screening enemy observation.

d. Direct-fire missions may include the delivery of fires against loopholes or openings in embrasures for the neutralization of weapons and the breaching of steel embrasure doors. Normally, direct-fire positions should be within 1,500 yards of the targets. In the ideal position, the howitzer is defiladed, or at least screened, from all works other than those on which it is to fire.

e. All means of communication must be employed to insure that howitzer fires can be opened or lifted as required. Fire is usually lifted as soon as the attacking infantry is ready to assault the target upon which a howitzer is firing.

f. Positions should be prepared before occupation. They will normally be occupied under cover of darkness, smoke, fog, artillery fire, or any combination thereof. Concealed routes to positions should be used. Every precaution must be taken to prevent premature discovery of weapons by the enemy.

42. RAIDS. a. For classification of raids, and the organization and conduct of raids by the infantry battalion or elements thereof, see **FM 7-20**.

b. The cannon company or cannon elements supporting a raid may be assigned either or both of the following general missions:

(1) Participation in artillery preparatory fires on the objective to be raided, with particular attention to the neutralization of known and suspected enemy

supporting weapons.

(2) Delivery of fires on adjacent or rear enemy positions and on avenues of enemy approach to the objective, for the purpose of assisting in isolating the objective, both during the raid and during the subsequent withdrawal. During the withdrawal, smoke may be employed to assist in screening the operation. Cannon units will be alert to engage enemy weapons capable of rendering support to the raided position.

c. The targets to be engaged and the time or signals for commencing and lifting fires are prescribed either by the commander ordering the raid or by the commander of the raiding force.

d. Unless the raid is to be conducted by a very small force, heavy weapons participate in the preparatory fires and in those fires delivered to isolate the objective: The fires of all cannon company elements will be closely coordinated with those of other supporting weapons and with the fires and maneuver of the raiding force.

e. Prior registration, preferably from one or more positions other than those which howitzers are to occupy for support of the raid, should be effected whenever possible. To preserve secrecy, registration should be spread out over a considerable period of time, and should include fires on points other than the assigned targets.

f. Firing positions occupied for the support of the raid should permit the rapid shifting of fires for the engagement of widely dispersed targets of opportunity, as well as the delivery of preparatory and protective fires.

43. DESERT OPERATIONS. a. Deserts vary greatly in character. The surface may consist of loose sand and dunes over which the movement of motor vehicles is greatly impeded, or it may be hard enough to permit free movement of mechanical transport at considerable speed. There are seldom any well-defined roads, but trails often exist between water sources. Owing to the scarcity of distinctive landmarks, maintenance of direction is often difficult. Mirage is a con-

stant source of error. Distances are deceptive and are frequently under-estimated.

b. When the surface consists of loose sand, operations in deserts will probably involve chiefly the use of foot troops, animals, and track laying vehicles. In such operations, use of the cannon company may be restricted because of reduction in the speed of its vehicles and added difficulties of movement.

c. Operations in deserts with a hard surface will permit the employment of all types of vehicles. In such operations, weapons of the cannon company can furnish powerful support because of their mobility and the flexibility of their fires.

d. Enemy air operations are very effective unless the most vigorous defensive measures are employed. While on the march, the fire of every available rifle, carbine, and machine gun should be brought to bear upon attacking enemy aircraft. (See par. 13.) While halted, vehicles and howitzers should be well-dispersed. Foxholes and emplacements should be dug; garnished camouflage nets should be used, as well as any available natural camouflage materials.

e. The tactical employment of the cannon company in desert terrain is similar to that in other types of terrain, except that the requirements for cover and concealment may require the occupation of firing position areas at greater distances in rear of the forward elements of supported units.

44. TACTICAL EMPLOYMENT IN THE ESTABLISHMENT OF A BEACHHEAD.

a. Since amphibious warfare takes on the characteristics of land warfare once the landing has been effected, cannon support for infantry troops attacking inland becomes an important factor in landing operations. Reduction of shore defenses prior to and during the initial stages of a landing constitute a separate phase of the landing, executed by naval gunfire and bombardment aviation. The mission of cannon company elements is to provide timely and effective fire support in close liaison with attacking infantry units to assist them in extending the beachhead inland once the landing has

been effected.

b. Cannon units should be landed as soon as practicable in order that they may take over the close-up support missions that are not within the capabilities of naval gunfire, and to supplement the supporting fires of artillery units. Plans should provide for the landing of a cannon platoon with each infantry assault battalion, after the assault echelon has secured the beach and the first terrain mask, or has moved inland a sufficient distance to remove small arms fire from the beach. Cannon elements landing with reserve infantry battalions should be prepared to fire without delay in support of the assault battalions.

c. A reconnaissance party consisting of personnel detailed from company and platoon headquarters should precede the landing of the platoons themselves. This party, under control of the reconnaissance officer, may be subdivided into two or three groups in order to select observation posts and firing position areas for each platoon. As the platoons are landed, they are guided into their respective positions by members of the reconnaissance party, who also assist in the establishment of wire communication between observation posts and firing positions.

d. Full organic loads of, ammunition are landed with each platoon; arrangements are made in advance for additional ammunition to be unloaded at the earliest practicable moment.

e. While control of individual platoons is necessarily decentralized to platoon leaders during landing operations and during the initial stages of the attack inland, the company commander must promptly establish and maintain contact with all elements of the company. While the platoons will frequently be operating under mission-type orders, the company commander will retain such control as may be necessary in order to provide the maximum support to the regimental plan of action.

45. MOUNTAIN OPERATIONS. a. Mountain warfare is characterized primarily by the difficulties which the terrain offers to movement and observa-

tion. The inaccessibility of certain regions restricts areas in which units are able to operate. The tactical employment of the cannon company in mountain warfare corresponds to that in other types of operations, with the necessary modifications and restrictions necessitated by the terrain.

b. Mountain warfare usually requires a decentralization of operations. Tactical groups frequently operate semi-independently within terrain compartments in order to carry out the plan for the force as a whole. Control of the cannon company is decentralized; the attachment of cannon elements to infantry units is frequently necessary in order to insure the most effective support and control.

c. The infantry howitzer attains increased importance as a close-support weapon because of its capabilities of clearing masks and of delivering fires against defiladed targets.

d. Lack of adequate observation and communication facilities will often require extensive reconnaissance. Personnel in the company command group must be utilized to the maximum to assist the platoons in the selection of observation posts, firing positions, and routes for the movement of howitzers and vehicles.

e. Howitzers will be emplaced near existing roads and trails, if practicable, in order to minimize the difficulty of movement to and from position and to facilitate the supply of ammunition.

f. In addition to the more usual missions of engaging enemy supporting weapons, cannon units may also be assigned the missions of neutralizing enemy observation posts and delivering interdiction fires. The effectiveness of interdiction fires is increased because of the number of definite points which the enemy is compelled to pass.

The Army formed one specified mountain division in WWII, the 10th Infantry; it conducted mountain training in Aspen, Colorado. Some other formations had severe requirements for mountain operations, particularly in New Guinea. Cannon companies in such regiments were generally armed with the 75mm pack howitzer, which could be transported over rough terrain by mule. Once such operations concluded, units of this kind were superfluous; the 6th Ranger Battalion in the Pacific was originally a mule-packed artillery unit.

Chapter 5

DEFENSIVE COMBAT

Section I. GENERAL

46. GENERAL. a. In the defense, the combat action of the cannon company is not static in the sense that the howitzers remain constantly in one position, or that sections prepare to expend all of their power on a single target area or sector of fire. Platoons take full advantage of the flexibility and mobility of the howitzers.

b. In supporting the defensive action of the regiment, cannon company howitzers are capable of delivering long-range, mid-range, and close-protective fires by indirect laying from defiladed positions in the regimental sector. They may also be employed to engage appropriate targets by direct laying. In the usual situation, targets should be mainly close-in targets of opportunity.

Section II. EMPLOYMENT IN DEFENSE

47. MISSIONS. a. The principal mission of the cannon company in defense is to provide close support to front-line infantry units by destroying or neutralizing hostile troops and weapons which threaten the friendly defensive position. This mission involves, primarily, the engagement of targets of opportunity which are not being effectively engaged by other supporting weapons. (See **FM 7-40**.) In addition, the platoons must be prepared to deliver concentrations of fire, on call, from prepared data on predetermined

localities. Such concentrations are planned in order to permit the rapid placing of howitzer fires on areas likely to be occupied by enemy troops or supporting weapons, the covering of road blocks and demolitions, the blocking of narrow defiles, or the denial to the enemy of certain critical areas for short periods of time. Concentrations should also be prepared for the purpose of supplementing the close-defensive fires of the 81-mm mortars and supporting artillery. (See par. 7.)

b. As a secondary mission, the regimental commander may direct that elements of the cannon company be employed to supplement or add depth to the antimechanized defense of the regiment. To accomplish this mission, the howitzer officer, after consultation with the anti-tank officer, selects supplementary positions to which howitzers may be moved, if necessary, to engage penetrating enemy armored vehicles. (See **FM 7-35**.)

48. DISTRIBUTION OF CANNON ELEMENTS. The howitzers of the cannon company are distributed within the regimental sector of the battle position. One platoon is usually placed in support of each front-line battalion, while the remainder of the company, if any, is placed in support of the regiment as a whole. (See **FM 7-20**.) Whenever the terrain permits, howitzers are initially emplaced in carefully concealed or camouflaged firing positions, prepared to deliver indirect fires either by platoon or by individual section; or the howitzers are held in cover positions from which they may be moved quickly by hand into firing positions in partial defilade for the delivery of direct fires. Observation posts are installed and telephone communication established with the howitzer firing positions for the control and conduct of fire. Whenever the tactical situation permits, the data for prearranged fires should be corrected by registration on a base point. Platoon leaders prepare overlays for their platoons. Copies are submitted to the company commander and combined to show the fire plan of the company. This fire plan is submitted to the regimental commander.

See 7-35 for the technical limitations of using HE rounds to engage heavy armor. Such munitions may shake up a tank, and a lucky shot may immobilize the vehicle by damaging its suspension or its engine, but is unlikely to penetrate the armor on a medium of heavy tank.

For this reason, cannon company assets, when they must be used to protect against an armor threat, should be positioned relative to the avenues of enemy approach to allow hits on vulnerable parts of the tanks.

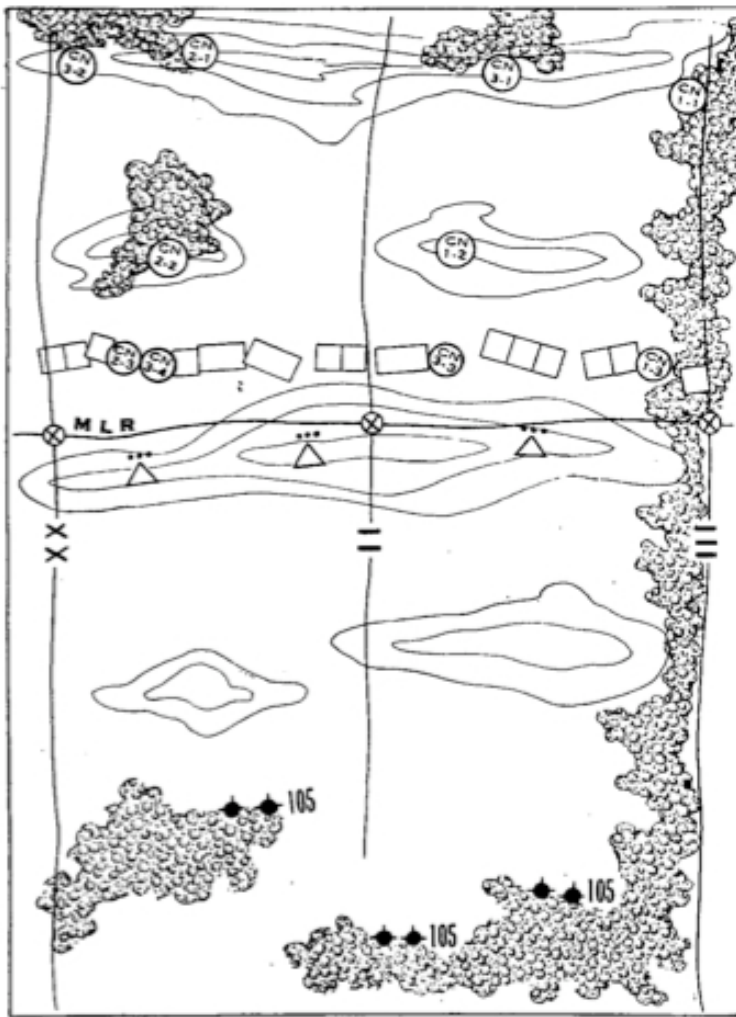

Figure 9. Support of a regiment in the defense. (Schematic) Flat-trajectory weapons cover gaps in concentrations in front of the main line of resistance. Howitzer concentrations other than those in front of the main line of resistance cover points likely to be occupied by supporting weapons or observation posts of the enemy when he launches his coordinated attack. Figure to the left of the dash in concentration symbol indicates number of cannon platoon; that to the right, number of concentration for that platoon.

49. CONDUCT OF THE DEFENSE. a. During the enemy's approach to the battle position, cannon observers are alert to discover and engage appropriate tar-

gets for the purpose of assisting in delaying the advance of the enemy, disorganizing his formations, and forcing him to deploy prematurely. This may be accomplished by' the interdiction of routes of approach to the battle position along which enemy movement is detected; by the delivery of concentrations of fire against known or suspected assembly areas; or by the neutralization or destruction of hostile long-range supporting weapons. (See figs. 2. and 9.) Cannon company elements may also be employed to provide close support to combat out- posts or to cover their withdrawal.

b. During the course of the enemy's coordinated attack against the battle position, the principal mission of cannon company elements is the neutralization or destruction of weapons supporting the hostile attack. Fires against such targets of opportunity may be delivered upon call from the commanders of supported units or upon the initiative of individual cannon observers. A cannon platoon leader or a liaison agent from the platoon is, usually with the commander of each front-line battalion for the purpose of providing close liaison and insuring the prompt delivery of fires which may be requested by the battalion commander. The cannon company commander also maintains close liaison with the regimental commander and the artillery commander, either personally or by designating some member of the company command group as a liaison agent.

c. If the enemy succeeds in effecting a close approach to the main line of resistance, the primary mission of cannon company elements is still the neutralization or destruction of hostile supporting weapons. However, they should be prepared to deliver concentrations of fire rapidly on call for the purpose of supplementing the prearranged close defensive fires of 81-mm mortars and supporting artillery. (See fig. 9.) Such concentrations are delivered from fire data which has been previously computed and recorded within each platoon and coordinated with that delivered against primary target areas by the mortars, and with the normal artillery barrages. (See par. 7.)

d. In the event of a counterattack against enemy

elements which may have penetrated the battle position, cannon company units will normally support such a counterattack by the rapid delivery of a heavy concentration of fire on remunerative targets within the penetrated area, and the prompt lifting or shifting of such fire upon signal or request from the counterattacking force. Such support requires careful advance planning and coordination between reserve infantry units and supporting artillery, and the cannon elements which are to provide the fire support.

Section III. RETROGRADE MOVEMENTS

50. GENERAL. For the fundamental doctrines governing retrograde movements, see **FM 100-5**. For principles and methods applied by the infantry regiment and battalion, see **FM 7-40** and **FM 7-20**.

51. NIGHT WITHDRAWAL. During a night withdrawal, elements of the cannon company will frequently be attached to the covering force. Cannon elements located in the areas of front-line battalions will usually be attached to such battalions for withdrawal to battalion assembly areas. Further withdrawal will be under cannon company control. Cannon elements not attached to the covering force will withdraw with the remainder of the regiment.

52. DAYLIGHT WITHDRAWAL. a. During a daylight withdrawal, the regiment may be assigned in whole or in part to the general covering force, or it may be required to break contact with the enemy and withdraw, protected either by the general covering force or solely by designated elements of the regiment.

b. The covering force for a regiment will ordinar-

ily not be larger than a reinforced battalion. One cannon platoon will frequently be attached to the battalion executing the covering mission in order to provide close support to the battalion in its initial delaying position and in such successive delaying positions as it may occupy.

c. When the regiment acts as the general covering force of a larger unit, one cannon platoon will normally be attached to each battalion occupying delaying positions, while the remainder of the company will support the action of the regiment as a whole. Particular attention will be devoted to covering the withdrawal of troops in forward delaying positions, and to the support of counterattacks. When, a counterattack is executed by the regiment as a whole, the cannon company is employed as indicated in paragraph 37.

53. RETIREMENT. a. If a regiment in contact with the enemy is to execute a retirement, it must first execute a withdrawal from action. During the withdrawal, the cannon company is employed as indicated in paragraphs 51 and 52.

b. After contact is broken, the regiment is regrouped in assembly-areas and the march column formed.

c. During the retirement, elements of the: cannon company will usually be attached to the regimental rear guard, and will engage appropriate targets at long ranges in order to force the enemy to deploy and thus delay his advance.

54. DELAYING ACTION. a. The purpose of delaying action is to gain time while avoiding decisive action. It is characterized by a maximum of long-range fire action and a minimum of close combat.

b. When the regiment is conducting a delaying action on one position, the employment of the cannon company is not materially different from that in a sustained defense, except that cannon elements will normally be attached to designated units of the regiment, especially when a withdrawal over widely

separated routes is contemplated.

c. (1) When successive positions are to be occupied, and a portion of the company remains under direct control of the company commander, he employs his reconnaissance personnel to reconnoiter the first delaying position for tentative firing positions. As time permits, this reconnaissance is extended to the rear to include the next delaying position and routes thereto. When all platoons are attached to subordinate units of the regiment, the company commander employs his reconnaissance and other command group personnel to assist the platoons in reconnaissance, as guides, in control, and in ammunition supply.

(2) If practicable, position areas should be such that firing positions may be located near topographical crests, with nearby cover for prime movers to facilitate withdrawal. Fire is opened on hostile elements at the longest practicable ranges in order to disorganize and delay the attack. During the withdrawal from one delaying position to another, cannon elements, protected by riflemen, may occupy intermediate positions to harass the enemy, slow down his advance, and cover road blocks and other obstacles.

d. In open country, where the hostile forces have great freedom of maneuver, cannon company elements, in addition to executing long-range fire missions, will also devote particular attention to the interdiction of any detected enemy movement toward the flanks.

Section IV. SPECIAL OPERATIONS

55. DEFENSE IN WOODS. a. When the regiment occupies a defensive position in woods, cannon elements may be attached to forward battalions (see **FM 7-20**); otherwise, the company is employed under the command of the company commander in accordance with the regimental plan of defense.

b. Facilities for observation, locations affording mask clearance for indirect fire and those with adequate fields of fire for direct fire vary according to the density and nature of the woods. Observation may frequently be obtained from some point on commanding ground within the woods, from positions in trees, or along the edges of large clearings. Positions both for indirect and direct firing may be prepared by clearing openings and lanes in the trees.

c. Adequate local protection against attacks by infiltrating enemy groups must be provided for all cannon company elements.

56. DEFENSE OF TOWNS. **a.** In the defense of towns, cannon company elements may be attached to battalions. (See FM 31-50.) Elements so attached may in turn be attached to rifle companies.

b. Howitzers of the cannon company are employed to cover roads, bridges, defiles, and other avenues of approach toward the edge of the town, as well as streets and open areas within the built-up area. In order to engage attacking enemy elements as they approach the edge of the town, howitzers may be emplaced initially in positions outside the town with observation posts located on prominent terrain features or in windows and on roofs of buildings overlooking the approaches. Howitzers may also be employed from positions within the town, such as the edges of open parks or squares, or on terrain features affording clearance over surrounding buildings.

c. After the attacking enemy forces have entered the town, howitzers are employed principally in close support of the defense by direct fires at comparatively short ranges. These weapons cover bridges, barricades, street intersections, and open areas, and are particularly alert to engage any enemy supporting weapons located in buildings, behind piles of debris or rubble, or in the cellars of demolished buildings.

57. DEFENSE OF A RIVER LINE. **a.** When the regiment is defending a normal frontage along a river line, elements of the cannon company are employed

as in the normal defense of the regimental sector of a battle position. (See **FM 7-20**.) Howitzers and observation posts are located in positions which will permit the engagement of enemy troops and supporting weapons beyond the far bank of the river, and which will also permit the delivery of close defensive fires on the far bank and on the river itself.

b. When wide frontages have been assigned, the near bank of the river may be lightly held by outguards. In such defense, the bulk of each frontline battalion is held mobile, prepared to occupy any one of several possible defense areas so as to block attempted enemy crossings. Cannon company elements are usually assigned missions with one platoon in support of, or attached to, each front-line battalion and the remainder of the company supporting the regimental reserve. Prior to the enemy attack, all cannon elements must carry out extensive reconnaissance for the selection of supplementary firing positions and routes thereto, in order that their fires may be delivered against an attempted crossing at any point. (See par. 40.) Counterattacks made by a battalion reserve will be supported by the cannon platoon supporting or attached to that battalion. If the enemy threatens to gain a foothold on the near bank and a counter-attack is made by the regimental reserve, the counterattack may be supported by the fires of all three cannon platoons.

58. DEFENSE AGAINST AIRBORNE OPERATIONS. a. In general, security measures against all enemy landing forces are designed to isolate and destroy such forces by immediate attack before they can be resupplied and reinforced with supporting weapons or before they can occupy any critical terrain features.

b. When the number and size of probable landing areas for airplanes and gliders are so limited that an effective defense of each area can be established, all troops may be distributed for static defense of these areas. When possible landing areas are so numerous that an effective static defense of each area cannot be provided, the entire force may be held mobile.

c. Elements of the cannon company may be attached to any unit of the regiment employed as a task force in defending areas against airborne attack. Howitzer targets include airplanes and gliders as they land, and areas defiladed from flat-trajectory fire in which enemy landings have been observed or reported, or in which enemy airborne troops are reorganizing preparatory to an attack. (See **FM 7-20**.) Firing positions should permit the delivery of observed fires on possible landing areas for hostile aircraft, and the support of friendly counterattacks.

d. Riflemen should be detailed for the local protection of all cannon company elements. When an enemy attack develops, such troops, together with all cannon personnel not immediately required for operation of the howitzers, coordinate their fire with that of the friendly troops in the immediate vicinity. Unless otherwise directed, drivers remain with and defend their vehicles.

59. DESERT OPERATIONS. For a discussion of desert operations, see paragraph 43.

60. MOUNTAIN OPERATIONS. For a discussion of mountain operations, see paragraph 45.

Appendix I

STREAM CROSSING EXPEDIENTS FOR HOWITZERS AND VEHICLES

1. GENERAL. It is frequently necessary to cross howitzers and vehicles to the far bank of an unfordable stream when no bridges are available, and before engineer troops can establish bridges or vehicular ferries. The expedients described herein may be employed in such a situation.

2. FLOTATION OF HOWITZERS—GENTLY SLOPING BANKS (fig. 10). a. The howitzer can be floated and towed across a stream by the use of three brush rafts. The procedure is as follows:

(1) The canvas cover of a 1½-ton truck is used for each of two large rafts. The canvas cover of a ¾-ton truck is used for one small raft. Brush bundles are built of sufficient size so that, when laid side by side in the center of the canvas, the canvas will extend beyond them about 18 inches on all four sides. The sides and ends of the canvas are then raised to form side walls, and are secured by tie ropes. The walls of the canvas should be as nearly vertical as possible.

(2) It is desirable to tie the brush in separate bundles of such size that each can be conveniently moved by one man, before placing on the canvas. The bundles should be made the full length of the area to be filled, but not more than 2 feet wide and 16 inches high. To build such a bundle, stakes are driven into the ground to outline the desired size of the brush bundle. Either green or dry brush is piled between the stakes and bound with rope, marline or old telephone wire. The ends of the brush are trimmed by cutting with a machete or other cutting tool so as to provide a square end to the bundle.

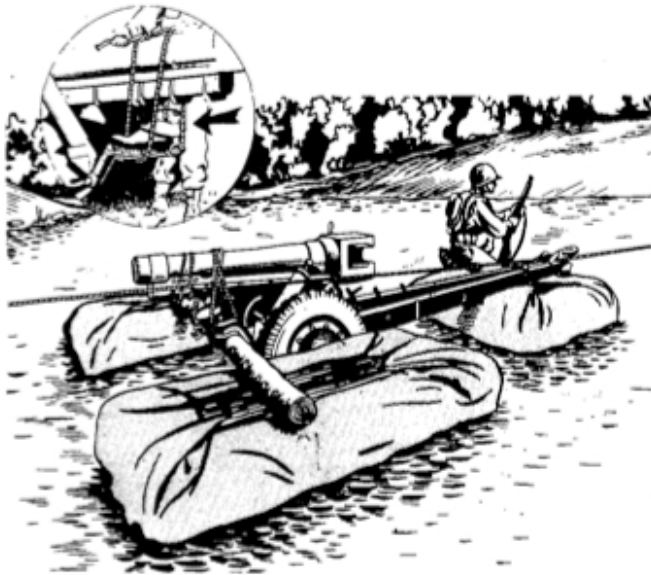

Figure 10. Flotation of howitzer.

(3) A pole 10 to 12 inches in diameter, and about 14 feet long, is cut. The trails of the howitzer are locked. The firing base is unlocked and lowered until its elbows can be fitted around the center of the pole. After they have been so fitted, the muzzle is depressed until the barrel is horizontal, and the barrel and firing base are lashed to the pole (fig. 10).

(4) A sandbag ramp should be constructed to facilitate the movement of the piece into the water (fig. 11). The howitzer is moved into the water by hand, trail first, and the end of the trail placed on the small raft, with spades clear of the raft and projecting just beyond its edge. The large rafts are floated into position close to and parallel with the wheels, and with their centers under the pole. As the howitzer is moved into the water, the rafts are kept in the same relative position until they support the pole, and with it, the piece. When the howitzer is completely floated, it is towed across the stream.

b. If available, a rubber boat of the five-man reconnaissance type may be used instead of the, small raft.

Otherwise, the arrangement is similar to the above method. Somewhat higher flotation is thus provided.

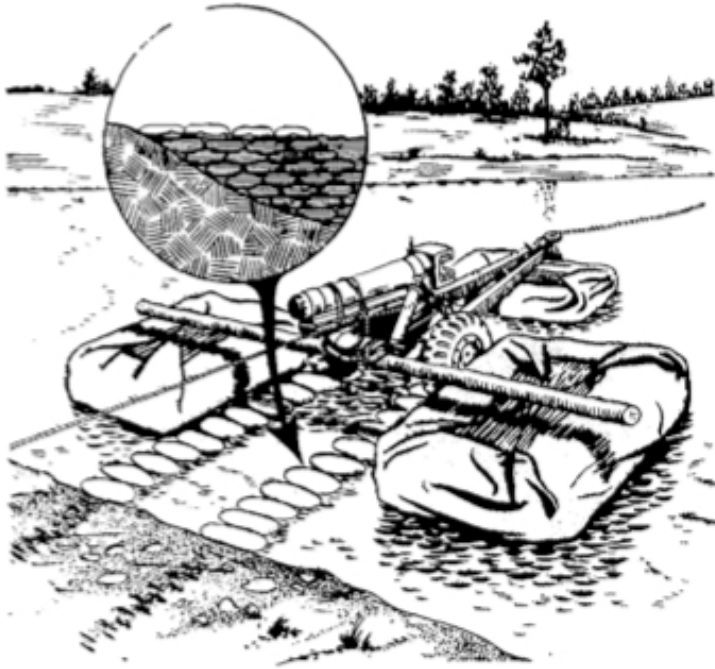

Figure 11. Flotation of howitzer.

c. Ammunition and personnel must be separately crossed, utilizing brush rafts or boats, if available.

3. FLOTATION OF $\frac{1}{4}$ -TON TRUCKS—GENTLY SLOPING BANKS. A $\frac{1}{4}$ -ton truck with three men and its normal load of ammunition and equipment can be floated across the stream by the use of four small brush rafts, employing the canvas covers of $\frac{3}{4}$ -ton or $1\frac{1}{2}$ -ton trucks. (See fig. 12.) Two poles, each 16 or 18 feet long, are cut. One is securely fastened with wire or rope to the front bumper of the truck so that it projects approximately equally on each side; the other is similarly fastened to the rear bumper. Two brush rafts are spotted in the water so that the truck can be driven between them. The fan belt of the truck is disconnected to avoid flooding the motor with water. The truck is then moved under its own power until the front pole rests on the center of the rafts. This will float the front end of the truck. It is then moved, under its own power, still farther into the stream until the other two brush rafts, can be placed in like man-

ner under the ends of the pole fastened to the rear bumper. If the banks shelve so rapidly as to make the above method impracticable, the brush rafts may be lashed to the ends of the saplings before the vehicle is moved into the water. With the entire load floating, the truck is towed across the stream. On arrival at the opposite bank, the brush rafts are removed from the front end of the vehicle and the truck is pulled out of the stream or run out under its own power.

4. FLOTATION OF $\frac{3}{4}$ -TON TRUCKS—GENTLY SLOPING BANKS. The $\frac{3}{4}$ -ton truck can be ferried across a stream in a manner similar to that described for the $\frac{1}{4}$ -ton truck. Brush rafts employing canvas covers of $1\frac{1}{2}$ -ton or larger trucks are used, constructed as described for the flotation of the howitzer. The poles fastened to the front and rear bumpers of the truck must be somewhat longer than those used for the $\frac{1}{4}$ -ton truck, and not less than 8 inches in diameter.

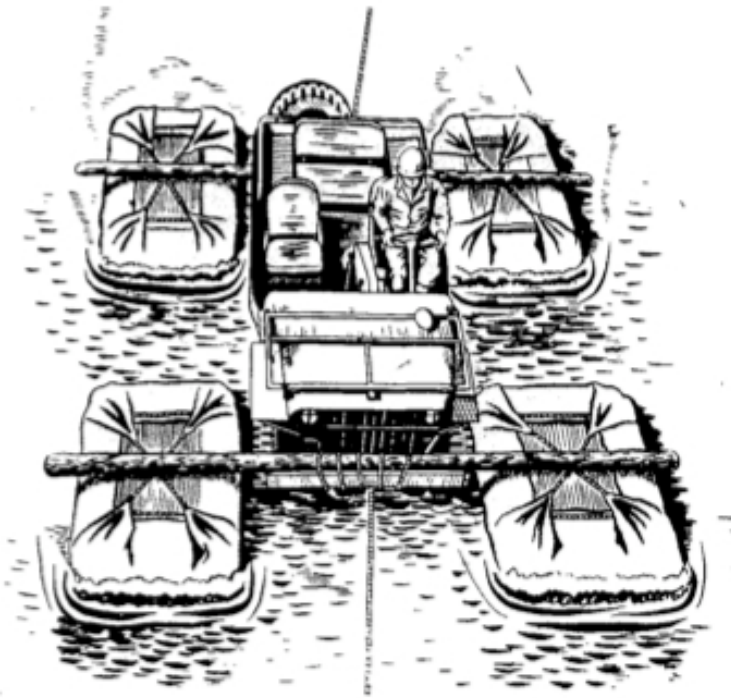

Figure 12. Flotation of $\frac{1}{4}$ -ton truck on brush raft.

5. FLOTATION OF LARGER VEHICLES. Flotation by rafts of vehicles larger than the $\frac{3}{4}$ -ton truck is usually impracticable. However, flotation of such vehicles, as well as $\frac{3}{4}$ -ton trucks, may be effected by the employment of canvas tarpaulins. Although infantry units are not equipped with tarpaulins of suitable size for this purpose, large tarpaulins, 20 feet 6 inches by 40 feet, are issued to each field artillery battalion in the division. These tarpaulins may be used to float trucks as follows:

a. A launching site is selected which provides access to the stream at a point where the drop-off is free from stumps, rocks, and roots, and deep enough under the center of a tarpaulin (placed as described in, b below) to float the vehicle. Empty vehicles float with the waterline approximately 6 inches below the top of the fender. It may be necessary to deepen the stream at the launching and beaching points.

b. The tarpaulin is spread at the water's edge and dragged over the water with a few feet of one end resting on the bank. (See fig. 13.) Men should be stationed about every 3 feet around the tarpaulin to hold the edges out of the water.

c. A piece of canvas or a folded truck cover should be stretched underneath the truck from bumper to bumper to prevent U-bolts, spring shackles, and other sharp projections from tearing the tarpaulin.

d. Except with an extremely sharp drop-off, the truck should be driven onto the canvas front end first, using rear drive only. Men hold the sides and end of the tarpaulin out of the water as the truck is driven onto it. After the front wheels are afloat and the rear wheels lose traction, the tarpaulin is folded about the vehicle; the corners are tied diagonally. The tie ropes along the sides and ends of the tarpaulin are tied to convenient points on the body of the vehicle.

Caution.—If the front wheel drive is engaged, and the front wheels slip, there is danger of tearing the tarpaulin.

e. When wrapped in the tarpaulin, the truck can be pushed outward by the crew until it floats. The truck may then be towed across the stream by a truck

winch or by hand.

f. Flotation of the $\frac{1}{4}$ -ton truck in the cover of a $2\frac{1}{2}$ -ton truck may be effected in a manner similar to that described above.



Figure 13. Flotation of $1\frac{1}{2}$ -ton truck with tarpaulin.

6. AERIAL CABLE-WAYS. a. General. When the banks of a stream are high and steep, it is frequently impossible to launch or land heavy flotation equipment. For such streams and for ravines, up to widths of 200 feet, an aerial cable-way may be used to make a crossing. Ordinarily, this is prepared by attached engineers or members of battalion ammunition and pioneer platoons.

b. Equipment. The following equipment will be required:

Two $2\frac{1}{2}$ - or $1\frac{1}{2}$ -ton winch trucks.

Four 8-inch steel snatch blocks suitable for use on winch truck cables.

300 feet $\frac{3}{4}$ -inch manila rope.

Two towing chains from $2\frac{1}{2}$ - or $1\frac{1}{2}$ -ton trucks.

c. Selection of site for an aerial cable crossing. The best site for an aerial cable crossing is one in which the loads can be taken from a high bank to a low bank, or between banks of equal height. To go from a low bank to a high bank is very difficult, and should not be attempted unless absolutely necessary. For a double-cable crossing (the kind described herewith)

the site should have two large trees on each bank to support the cables. Each pair of trees should be located approximately 12 feet apart, and in such a place that the cables can be rigged directly in line with the winches on the trucks. The trees on the near bank should be not less than 30 feet and those on the far bank not less than 50 feet from the edge of the water. The farther away from the edge of the water the cables can be rigged on the far bank, the easier will be the crossing. If the center point of the cables is the point at which the equipment is to be landed, the crossing will be quickly effected and very easily controlled.

d. Safety precaution. It is possible to overload the cables. For this reason, it is essential that they be properly rigged to keep the loads within their carrying capacity. To be sure that they are properly rigged to carry loads up to 2,674 pounds (the weight of the howitzer) in double-cable crossings, allow 5 feet of slack for every 100 feet of cable. This limit is based upon a cable and winch capacity of 7,500 pounds. Slack must always be measured or estimated at the mid-point of the cables. (See fig. 14.) Additional slack in the cables will decrease the load thereon, and increase the factor of safety for the crossing. The cables must be in good condition, and free from kinks and snarls.

e. Rigging. (1) Drive the winch trucks into position so that their winch drums are in line with the cableways. Anchor both winch trucks firmly in place. Trucks can be anchored by butting them against trees, or by installing dead men or other suitable anchorages. For each cable, place a snatch block well up on the two trees on the bank of the stream where the trucks are located. These snatch blocks should be located high enough to allow for the slack required for the crossing. Place the cables through the snatch blocks, take them to the far bank and fasten them well up on the anchor trees which have been selected on that bank.

(2) To cross the $\frac{1}{4}$ -ton truck, place one snatch block on each cable. Take a pole 4 inches in diameter, 12 feet long, and notched near each end, and fasten one end

to the hook of each snatch block. This is the spreader pole, and should be wired to the hooks at the notches in order to keep the blocks from sliding together. (See fig. 15.) Fasten a hold-back line to the snatch blocks by tying the rope around them with a bridle. Fasten another rope in a similar manner and carry the free end to the far banks, where it is used to pull the load across the stream. A howitzer, in which the weight is distributed unevenly, will require two pairs of snatch blocks and two spreaders. With this rigging, the holdback line is fastened to the near snatch blocks and the pulling rope is fastened to the far snatch blocks. (See fig. 16.)

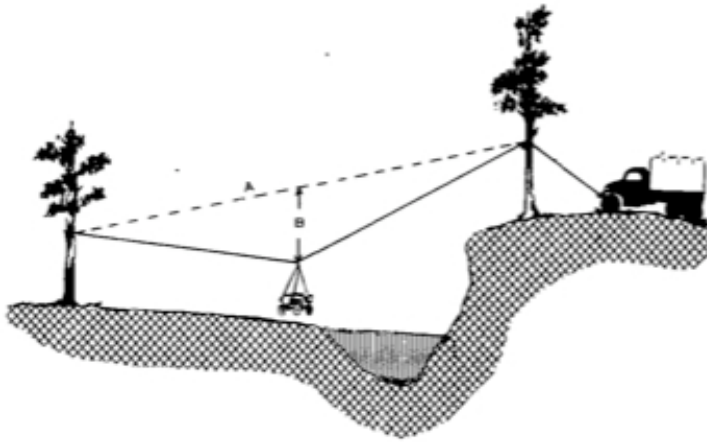

Figure 14. Method of measuring slack. Amount of slack, B, is measured or estimated at center of cable.



Figure 15. Aerial cableway showing movement of $\frac{3}{4}$ -ton truck by double-cable crossing.

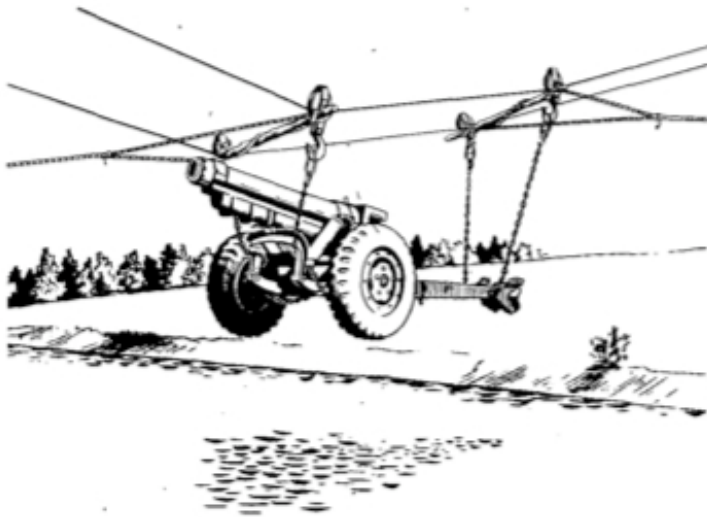

Figure 16. Aerial crossing of howitzer.

Appendix II

DIRECTIVES FOR TACTICAL TRAINING OF CANNON COM- PANY, INFANTRY REGIMENT

[Omitted.]